



**LIMPOPO**  
PROVINCIAL GOVERNMENT  
REPUBLIC OF SOUTH AFRICA

**DEPARTMENT OF  
AGRICULTURE AND RURAL DEVELOPMENT**

**TENDER NO ACDP 23/05  
TENDER DOCUMENT**

**FOR**

**CONSTRUCTION OF CHILI PEPPER DRYING FACILITY AT ROYAL FIELDS  
FARM UNDER MUSINA LOCAL MUNICIPALITY IN VHEMBE DISTRICT OF  
LIMPOPO PROVINCE**

<b>NAME OF TENDERER</b>	
<b>TOTAL TENDERED AMOUNT</b>	
<b>TOTAL TENDERED AMOUNT IN WORDS</b>	
<b>VAT NUMBER (if registered for VAT)</b>	
<b>SUPPLIER CSD REGISTRATION NUMBER</b>	
<b>TAX COMPLIANCE STATUS PIN (to verify bidder's tax compliance status)</b>	
<b>PROJECT DURATION</b>	
<b>TEL NUMBER</b>	
<b>FAX NUMBER</b>	

**PREPARED FOR:**



**LIMPOPO**  
PROVINCIAL GOVERNMENT  
REPUBLIC OF SOUTH AFRICA

**DEPARTMENT OF  
AGRICULTURE AND RURAL DEVELOPMENT**

**PREPARED BY**



**LIMPOPO**  
PROVINCIAL GOVERNMENT  
REPUBLIC OF SOUTH AFRICA

**DEPARTMENT OF  
AGRICULTURE AND RURAL DEVELOPMENT**

**HEAD OF DEPARTMENT  
LIMPOPO DEPT OF AGRICULTURE &  
RURAL DEVELOPMENT  
PRIVATE BAG X 9487  
POLOKWANE  
0700**

**ENGINEERING SERVICES VHEMBE DISTRICT  
LIMPOPO DEPT OF AGRICULTURE & RURAL DEVELOPMENT  
MAKWARELA GOVERNMENT COMPLEX  
SIBABA  
0970**

**CLOSING DATE: 22 JANUARY 2024 TIME 11:00 AM**

**BRIEFING MEETING: 15 JANUARY 2024 TIME 10:00 AM**



**LIMPOPO**  
PROVINCIAL GOVERNMENT  
REPUBLIC OF SOUTH AFRICA

**DEPARTMENT OF  
AGRICULTURE AND RURAL DEVELOPMENT**

**CONSTRUCTION OF CHILI PEPPER DRYING FACILITY AT ROYAL FIELDS  
FARM UNDER MUSINA LOCAL MUNICIPALITY IN VHEMBE DISTRICT OF  
LIMPOPO PROVINCE**

**TENDERER'S DETAILS**

**NAME OF TENDERER** .....

.....

.....

**PHYSICAL ADDRESS** .....

.....

.....

**POSTAL ADDRESS** .....

.....

.....

**CONTACT PERSON** (NAME).....

(SURNAME).....

(PHONE No).....

(CELL No).....

(FAX No).....

(E-MAIL).....

## LIMPOPO DEPARTMENT OF AGRICULTURE AND RURAL DEVELOPMENT

### CONSTRUCTION OF CHILI PEPPER DRYING FACILITY AT ROYAL FIELDS FARM UNDER MUSINA LOCAL MUNICIPALITY IN VHEMBE DISTRICT OF LIMPOPO PROVINCE

# Contents

Number | Heading

## The Tender

### Part T1: Tendering procedures

T1.1	Tender Notice and Invitation to Tender
T1.2	Tender Data
T1.3	Standard Conditions of Tender

### Part T2: Returnable schedules

T2.1	List of Returnable Documents
T2.2	Returnable Schedules to be completed by tenderer

## The Contract

### Part C1: Agreement and Contract Data

C1.1	Form of Offer and Acceptance
C1.2	Contract Data
C1.3	Form of Guarantee
C1.4	Agreement with Adjudicator
C1.5	Agreement in Terms of Section 37(2) of the Occupational Health and Safety Act No 85 of 1993

### Part C2: Pricing data

C2.1	Pricing Instructions
C2.2	Bill of Quantities

### Part C3: Scope of Work

C3.1	Standard Specifications
C3.2	Project Specifications
C3.3	Particular Specifications

### Part C4: Site information

C4.1	Locality Plan
------	---------------

## Drawings

### SCHEDULE OF TENDER DRAWINGS

The following drawings, which are bound in, form part of this Contract in terms of Clause 1(i)(j) of the General Conditions of Contract:

DRAWING NO:	DESCRIPTION:
RFF01	Layout
RFF02	Foundation
RFF03	Cross Section

The Tenderer shall satisfy himself that the sets of drawings are complete in accordance with the above schedule, and if any are found to be missing or duplicated, or the writing or figures indistinct, he shall apply to the Engineer immediately and have the discrepancy rectified. No liability whatsoever will be admitted by the Employer in respect of errors in Tenders attributed to any such discrepancy.

## PART T1: TENDERING PROCEDURES

<b>TABLE OF CONTENTS</b>		<b>Page</b>	<b>Colour</b>
<b>T1.1:</b>	<b>TENDER NOTICE AND INVITATION TO TENDER .....</b>	<b>T.2</b>	<b>White</b>
<b>T1.2:</b>	<b>TENDER DATA .....</b>	<b>T.3</b>	<b>Pink</b>
<b>T1.3:</b>	<b>ANNEXURE F: STANDARD CONDITIONS OF TENDER .....</b>	<b>T.9</b>	<b>Pink</b>

## T1.1: TENDER NOTICE AND INVITATION TO TENDER



**LIMPOPO**  
 PROVINCIAL GOVERNMENT  
 REPUBLIC OF SOUTH AFRICA

### DEPARTMENT OF AGRICULTURE AND RURAL DEVELOPMENT

**TENDER NO ACDP 23/05**

### CONSTRUCTION OF CHILI PEPPER DRYING FACILITY AT ROYAL FIELDS FARM UNDER MUSINA LOCAL MUNICIPALITY IN VHEMBE DISTRICT OF LIMPOPO PROVINCE

#### T1.1 Tender Notice and Invitation to Tender

Tenders are hereby invited to bid for the Construction of Chili Pepper Drying Facility at Royal Field Farm under Musina Local Municipality in Vhembe District of Limpopo Province. **Bidders who have 4 CE/ME or higher CIDB grading are targeted for this bid.**

Tender documents will be obtainable from the departmental website: [www.lard.gov.za](http://www.lard.gov.za). Bid documents must be printed and bound in the order/sequence/numbering provided. No omission of pages/ documents will be allowed.

Duly completed tenders enclosed in a sealed envelope marked **“TENDER: CONSTRUCTION OF CHILI PEPPER DRYING FACILITY AT ROYAL FIELDS FARM UNDER MUSINA LOCAL MUNICIPALITY IN VHEMBE DISTRICT OF LIMPOPO PROVINCE TENDER NO ACDP 23/05, CLOSING DATE: 22 JANUARY 2024”** with the name of the Tenderer, shall be deposited in the clearly marked tender box provided at Limpopo Department of Agriculture and Rural Development, 69 Biccard Street, Polokwane before 10h00 on the closing date. The tenders will be opened in public.

A Compulsory Site Inspection will be conducted on **15 JANUARY 2024** and prospective tenderers are requested to meet the Engineer at 10h00 at the Royal field project that is located in Manenzhe village, 130 km outside Musina town, in the Musina local municipality, having GPS co-ordinates **22°27'13.05"S 30°30'7.65"E**. Contract documentation will not be available on site, and the Engineer will not be available for inspection purposes on any other occasion.

A preferential point system shall apply whereby a contract will be allocated to a tenderer in accordance with the Preferential Procurement Policy Framework Act, Act No 5 of 2000 and as defined in the Conditions of Tender in the tender document, read in conjunction with the Preferential Procurement Policy of Limpopo Department of Agriculture where 80 points will be allocated in respect of price and 20 points in respect of targeted goals. Tenderers must have the necessary skills, experience and capacity to perform the required work.

<b>Engineer:</b>	<b>Employer:</b>
<b>Limpopo Department of Agriculture &amp; Rural Development</b> Head of Department Makwarela Government Complex Private Bag X2247 Sibasa 0970 Mr L Nemakhavhani Tel.: 015 963 2005 Cell.: 0716043403	<b>Limpopo Department of Agriculture &amp; Rural Development</b> Head of Department Limpopo Dept of Agriculture and Rural Development Private Bag X9487 Polokwane 0700 Ms M. Mononyane Tel.: 015 294 3434

---

## T1.2. TENDER DATA

The Conditions of Tender in the Standard Conditions of Tender as contained in Annex F of CIDB Standard Uniformity in Construction Procurement. (See [www.cidb.org.za](http://www.cidb.org.za)) which are reproduced without amendment or alteration for the convenience of Tenderers in this Tender in the section T1.3 of the Tender Data.

The Standard Conditions of Tender make several references to the Tender Data for details that apply specifically to this Tender. The Tender Data shall have precedence in the interpretation of any ambiguity or inconsistency between it and the Standard Conditions of Tender. Each item of Tender Data given below is cross-referenced to the relevant clause in the standard Conditions of Tender.

**F.1.1** The Employer for this Contract is: **Limpopo Department of Agriculture and Rural Development**

### F.1.2 Tender Documents

The Tender Document consists of the following:

#### TENDER

##### **T1: Tendering Procedures**

- T1.1: Tender Notice and Invitation to Tender
- T1.2: Tender Data
- T1.3: Standard Condition of Tender

##### **T2: Returnable Documents**

- T2.1: List of Returnable Documents
- T2.2: Returnable schedules

#### CONTRACT

##### **Part 1: Agreements and Contract Data**

- C1.1: Form of Offer and Acceptance
- C1.2: Contract Data
- C1.3: Form of Guarantee
- C1.4: Agreement with Adjudicator
- C1.5: Agreement in terms of Section 37(2) of the Occupational Health and Safety Act (No 85, 1993)

##### **Part 2: Pricing Data**

- C2.1: Pricing Instructions
- C2.2: Bill of Quantities

##### **Part 3: Scope of Work**

- C3.1: Standard Specifications
- C3.2: Project Specifications
- C3.3: Particular Specifications

##### **Part 4: Site Information**

- C4.1: Locality Plan
- C4.2: Construction Notice Board

#### DRAWINGS

Drawings are bound in this document.

The Tender Document and the drawings shall be obtained from the Employer or his authorized representative at the physical addresses stated in the Tender Notice, upon

payment of the deposit stated in the Tender Notice.

**F.1.4 The Employer's agent is:**

Name : Mr L Nemakhavhani

Address: **Limpopo Department of Agriculture & Rural development**  
Makwarela Government Complex  
Private Bag X2247  
Sibasa  
0970

Tel: 015 963 2005  
Cell: 071 604 3403  
Email: [nemakhavhanil@agric.limpopo.gov.za](mailto:nemakhavhanil@agric.limpopo.gov.za)

**F.1.5 The Employer's right to accept or reject any Tender Offer**

The Employer may accept or reject any variation, deviation, Tender Offer, or alternative Offer, and may cancel the Tender process and reject all Tender Offers at any time before the formation of a Contract. The Employer shall not accept or incur any liability to a Tenderer for such cancellation and rejection, but will give written reasons for such action upon written request to do so. The Employer will reserve the right to appoint more than one (1) bidder.

**F.2.1 Eligibility**

A Tenderer will not be eligible to submit a Tender if:

- (a) The Contractor submitting the Tender is under restrictions or has principals who are under restriction to participate in the Employer's procurement due to corrupt or fraudulent practices;
- (b) The Tenderer does not have the legal capacity to enter into the Contract;
- (c) The Contractor submitting the Tender is insolvent, in receivership, bankrupt or being wound up, has his affairs administered by a court or a judicial officer, has suspended his business activities, or is subject to legal proceedings in respect of the foregoing;
- (d) The Tenderer does not comply with the legal requirements stated in the Employer's procurement policy;
- (e) The Tenderer cannot demonstrate that he possesses the necessary professional and technical qualifications and competent, financial resources, equipment and other physical facilities, managerial capability, personnel, experience and reputation to perform the Contract;
- (f) The Tenderer cannot provide proof that he is in good standing with respect to duties, taxes, levies and contributions required in terms of legislation applicable to the work in the Contract.
- (g) Only those Tenderers who have in their employ management and supervisory staff satisfying the requirements of the Scope of Work for Labour Intensive Competencies for supervisory and management staff are eligible to submit Tenders.
- (h) Only those Tenderers who are registered with the CIDB as defined in the Regulations 09 June 2004 and 22 July 2005, in terms of the CIDB Act No 38 of 2000, or are capable of being so prior to the evaluation of submissions, in a Contractor grading designation equal to or higher than a Contractor grading designated determined in accordance with the Sum Tendered for a **4 CE/ME or higher** class of construction work, are eligible to submit Tenders.
- (i) The Contractor submitting the Tender is not registered on the Central Supplier Database

Joint Ventures are eligible to submit Tenders provided that:

- 1. every member of the Joint Venture is registered with the CIDB;
- 2. the lead partner has a Contractor grading designation **4 CE/ME or Higher** class of construction; and
- 3. the combined Contractor grading designation calculated in accordance with the Construction Industry Development Regulations is equal to or higher than a Contractor grading designation determined in accordance with the sum Tendered for a **4 CE/ME or Higher** class of construction work



## **F.2.7 Site visit and clarification meeting**

There will be a Compulsory Site Inspection, on **15 January 2024 at 10h00** on site.

Bidding tenderers are requested to meet the Engineer at 10h00 at Royal field project that is located in Manenzhe village, 130 km outside Musina town, in the Musina local municipality, having GPS coordinates 22°27'13.05"S 30°30'7.65"E".

## **F.2.10 Pricing the Tender Offer**

### **(a) Value Added Tax**

- The Valued Added Tax (VAT) rate shall be 15% or as otherwise provided for by Legislation.
- The successful Tenderer shall be required to produce a VAT invoice that shall only be prepared once measurements and valuations for work done in Terms of Contract Offer have been agreed with the Employers agent and a Certificate of Payment issued.
- Payment of VAT to non-VAT vendors shall be processed from the month in which the Tenderer's liability with the South African Revenue Services is effective.

## **F.2.11 Alterations to document**

A Tender Offer shall not be considered if alterations have been made to the Forms of Tender data or Contract data (unless such alterations have been duly authenticated by the Tenderer) or if any particulars required therein have not been completed in all respects.

## **F.2.12 Alternative Tender Offers**

No alternative Offers will be considered.

## **F.2.13 Submitting a Tender Offer**

### **F.2.13.3** Tender Offers shall be submitted as an original only.

Under no circumstances whatsoever may the Tender forms be retyped or redrafted.

Photocopies of the original Tender documentation may be used, but an original signature must appear on such photocopies.

### **F.2.13.5** The Employer's address for delivery of Tender Offers and identification details to be shown on such Tender Offer package are:

Location of Tender box: Limpopo Department of Agriculture and Rural Development  
Physical address: 69 Biccard Street Ground Floor  
Polokwane, 0700

## **IDENTIFICATION DETAILS: TENDER FOR CONSTRUCTION OF CHILI PEPPER DRYING FACILITY AT ROYAL FIELDS FARM UNDER MUSINA LOCAL MUNICIPALITY IN VHEMBE DISTRICT OF LIMPOPO PROVINCE**

Tender No: **ACDP 23/05**

Closing Date: **22 January 2024 at 11:00**

**F.2.15 Closing Time**

The closing time for submission of Tender Offers is: **11h00 on 22 January 2024** as stated in the Tender Notice and Invitation to Tender.

Telephonic, telegraphic, telex, facsimile, electronic or e-mailed Tenders will not be accepted.

**F.2.16 Tender Offer validity**

The Tender Offer validity period is **120 days** from the closing time for submission of Tenders.

**F.2.18 Provide other material**

The Tenderer shall, when requested by the Employer to do so, submit the names of all management and supervisory staff that will be employed to supervise the labour-intensive portion of the works together with satisfactory evidence that such staff members satisfy the eligibility requirements

**F.2.19 Access**

Access shall be provided for inspections and testing by personnel acting on behalf of the Employer.

**F.2.20 BID EVALUATION CRITERIA**

Criteria	Requirements
Pre-compliance criteria	The Service Provider must submit all documents as outlined below.
Preferential points for specific goals	Bidders will be allocated preferential points for specific goals as per table 7.2.2 c

The evaluation process entails the following:

- a) Phase 1: Pre-Compliance evaluation
  - i. During this phase, bid responses are registered to ascertain the number of bid responses received before the closing date and time.
  - ii. The following key information of bidders will be verified on the CSD in line with Public Finance Management Act and regulatory requirements to qualify for further evaluation processes:
- b) Business registration including details of directorship and membership
- c) In the service of the state status
- d) Tax compliance status
- e) Identity number (s)
- f) Tender defaulting and restriction status, and
- g) Any additional and supplementary verification information communicated by National Treasury

**i. REQUIRED DOCUMENTS:**

Documents that must be submitted	Non-submission will result in disqualification	Requirement
Attend Compulsory Site Briefing	<b>YES</b>	Must attend the compulsory site briefing as per scheduled date and time and ensure to sign the attendance register.
Invitation to Bid – SBD 1	<b>YES</b>	Complete and sign the supplied pro forma document
Compulsory Enterprise Questionnaire	<b>YES</b>	Must be fully completed, signed by the authorized person/s in case of joint ventures and submitted with the bid by the closing date and time. <b>In case of J/V bidders should complete separate forms should be completed.</b>

Pricing Schedule – SBD 3.1	<b>YES</b>	Complete and sign the supplied pro forma document
Bill of Quantities	<b>YES</b>	All items of the BOQs must be fully completed and submitted with the bid by the closing date and time.
CIDB grading certificate of <b>4CE/ ME or higher</b>	<b>YES</b>	Bidder must submit CIDB grading certificate of <b>4CE/ ME or higher</b> . In case of Joint Ventures, both bidders <b>must</b> submit proof of the joint calculated CIDB Grading with their Bid. <b>Non-submission will lead to disqualification.</b>
Bidders Disclosure – SBD 4	<b>YES</b>	Complete and sign the supplied pro forma document. <b>(Must declare if they have interests in other Companies. Refer to Paragraph 2.3). In case of J/V bidders should complete separate SBD 4</b>
Preference Point Claim Form – SBD 6.1	<b>YES</b>	Non-Returnable of the supplied pro forma document will lead to Disqualification. <b>Non-claiming of points on this form will lead to zero (0) even if supporting documentation is attached</b>
Form of intent by a bank or insurance company to provide a performance guarantee and insurance of the works	<b>YES</b>	Must be submitted with the tender by the closing date and time of the bid.
Joint Ventures (J/V)	<b>YES</b>	Attach a valid JV agreement. Non-submission will lead to disqualification.  In the case of an award, the company need to register on CSD as a JV. The process is that the service providers must register the JV at SARS then open a JV bank account. With those documents they can then register the JV on CSD. <b>The department will only make payment to a JV account. Should complete 2 separate SBD 4 &amp; Compulsory Enterprise Questionnaire for each company</b>
Workmen's Compensation Registration Certificate	<b>NO</b>	Must submit valid copy of COIDA certificate or proof of payment thereof.
Completeness of the tender document	<b>YES</b>	Bidders are required to complete the entire bid document without omission of pages and in the provided sequence. The tender document to be fully completed in <b>Black ink (not typed)</b>
Specification	<b>YES</b>	Must comply with the specification
Bank Rating	<b>YES</b>	Bank rating letter from a financial institution. Bidders must have a minimum rating of C and have been with the Bank for at least 6 months.

ii. **The Service Provider must ensure that they meet the following requirements before the bid can be awarded:**

CRITERIA	REQUIREMENT
Tax compliance status	“Bidder must be tax compliant before the bid is awarded, i.e. <i>Where the recommended bidder is not tax compliant, the bidder will be notified of their non-compliant status and the bidder must be requested to submit written proof from SARS of their tax compliance status or proof that they have made an arrangement to meet their outstanding tax obligations within 7 working days. The bidder should thereafter provide the accounting officer or accounting authority with proof of their tax compliance status which should be verified via the Central Supplier Database or eFiling</i> ”
Business registration	The bidder must be registered on CSD and CSD must indicate that the bidder is active
Company registration with central supplier database (CSD)	Must be registered as a service provider on the Central Supplier Database (CSD). If not registered must proceed to complete the registration prior to submitting your proposal. Visit <a href="https://secure.csd.gov.za/">https://secure.csd.gov.za/</a> to obtain your vendor number.
In the service of the state status	The bid will not be considered if Shareholders or directors are employed by state/ government departments, municipalities, municipal entities, or public entities unless <b>the approval from executive authority to do business with the state is submitted with the proposal.</b>
Tender defaulting and restriction status	Entity and directors must not be restricted

## 7.2 FUNCTIONALITY

### 7.2.1 Functionality Evaluation Criteria = 100 points

The minimum score required for functionality is **70 points** in order to qualify for further evaluation. A bidder who scores less than **70 points** on functionality will be disqualified.

CRITERIA	EVIDENCE	VALUE	WEIGHTING
1. Physical Facilities	No Land line/cell phone or no information provided	0	5
	Land line/cell phone and fax line and e-mail address only	1	
	Physical address with proof of lease agreement, land line/cell phone, fax line, e-mail address.	3	
	Physical address with proof of ownership, land line/cell phone, fax line, e-mail address	5	
2. Plant and Equipment available owned or leased by the Bidder (provide proof of registration or letter of intent to hire from your supplier)	No information	0	15
	Hire 4 of the following: Hand tools, Truck or Tractor & Trailer, TLB/Excavator, Lifting Crane, Compactor, Concrete mixer, LDV's	1	
	Own or Hire 5 to 7 of the following: Hand tools, Truck or Tractor & Trailer, TLB/Excavator, Lifting Crane, Compactor, Concrete mixer, LDV's	3	
	Own All of the following: Hand tools, Truck or Tractor & Trailer, TLB/Excavator, Lifting Crane, Compactor, Concrete mixer, LDV's	5	
3. Program of Works (Execution Plan with	No information = Form not completed/ not attached	0	15

cash flow and method statement)	Irrelevant Gantt chart with a less detailed cash flow and method statement	1	
	Gantt chart within relevant activities, with cash flow and less detailed method statement	3	
	Clear applicable activities, Gantt charts, detailed methodology statement and completion is within contract duration and realistic cash flow	5	
<p>4. Current Works</p> <p>Current value refers to current value of projects for both Civil Engineering (CE) and Mechanical Engineering (ME).</p> <p><b>NB!! Completion of this table is mandatory for points to be allocated. Do not refer to any attachment. If no projects at the moment the tenderer must indicate on this table (Not applicable will be deemed as non-responsive). Misrepresentation of facts will render your bid non-responsive.</b></p>	Current value is equal or greater than twice the maximum value of the required CIDB grade	0	15
	Current value is greater than the maximum value of the required CIDB grade but less than twice the maximum value of the required CIDB grade	1	
	Current value is within the required CIDB threshold	3	
	Current value is less than the minimum value of the required CIDB grade	5	
<p>5. Staffing profile: Details of relevant staff experience available for this Contract (attach organization structure, CVs and certified qualifications)</p>	No information / CVs not attached	0	20
	Has at least 2 of the following personnel: Site agent/ Project manager, Foreman, electrician, plumber, safety officer, plant operator	1	
	Has 4 of the following personnel: Site agent/ Project manager, Foreman, electrician, plumber, safety officer, plant operator	3	
	Has all of the following personnel: Site agent/ Project manager, Foreman, electrician, plumber, safety officer, plant operator	5	
<p>6. Experience in similar works relevant to this technical field completed in the last 5 years (Steel structure and building, installation of processing equipment, installation of cold-rooms)</p>	No information / No proof attached	0	30
	1 similar work completed across any category (Steel structure and building, installation of processing equipment, installation of cold-rooms)	1	
	3 similar works completed across any categories with complete certification (Steel structure and building, installation of processing equipment, installation of cold-rooms)	3	

<p>Company profile and Proof indicating that the organisation is experienced must be submitted with the tender (<b>Proofs must include appointment letter and completion certificates accompanied by compulsory reference letters for each completed project must be submitted (refer to annexure A in the tender document)</b>)</p>	<p>5 or more similar works completed across any categories with complete certification (Steel structure and building, installation of processing equipment, installation of cold-rooms)</p>	<p>5</p>	
<b>Total</b>			100

**7.2.2 80/20 PREFERENCE POINT SYSTEM FOR GOODS AND SERVICES**

- a. The preferential points will be allocated for specific goals as prescribed in Section 2 of the Preferential Procurement Policy Framework Act (5 of 2000), Paragraph 3.2.1 and 7.7 of the Reconstruction and Development Programme White Paper of 1994 and the Broad-Based Economic Empowerment Act, 2003.
- b. The following formula must be used to calculate the points for price of tenders/procurement (quotations) including “tenders for income generating contracts” with Rand Value **below a Million** to be calculated as per the below table inclusive of all applicable taxes:

$$Ps = 80 - 1 \cdot \left( \frac{Pt - Pmin}{Pmin} \right)$$

Where:

Ps = Points scored for price of bid under consideration

Pt = Rand value of tender consideration

Pmin = Rand value of lowest acceptable tender

- c. A maximum of **20 points** will be awarded in accordance with the table below:

NO	PREFERANTIAL GOALS	20 POINTS	MEANS OF VERIFICATION
1	Black People ownership > 51%	5	CSD and/ or copy of company registration report
2	Women Ownership > 51%	6	CSD Report
3	Persons with Disability Ownership >51%	3	CSD and Medical Certificate from recognized Medical Practitioner
4	Youth Ownership >51%	6	CSD Report
<b>TOTAL POINTS</b>			

- d. The points scored by a tenderer in respect of the specific goals above must be added to the points scored for price and the total must be rounded off to the nearest two decimal places.
- e. **Only the tender with the highest number of points scored may be selected for an award.**

## 7 SPECIAL CONDITIONS

- 7.1 Bidders who intend to cede their rights to payment to an institution as prescribed in **No: 08 below** should attach cession agreement with their bid proposal.
- 7.2 Payment will only be made in accordance with the delivery of a service that will be agreed upon by both parties and upon receipt of an original invoice.
- 7.3 **It is compulsory for a person to register for VAT if the value of taxable supplies made or to be made, is in excess of R1 million**
- 7.4 The service provider is required to provide a quote for all items, failure to quote according to the specification will invalidate your bid.
- 7.5 **Inspection will be conducted on the top 3 scoring bidders.**
- 7.6 The Department will not make any upfront payment to a successful service provider.
- 7.7 The department reserves the right to conduct a risk assessment for the recommended service provider to verify the provided information and authenticate the supporting documentation and may disqualify the service provider if the risk analysis feedback is negative

## 8 CESSION

- a) Cession of payments will only be permissible to a registered financial institution in terms of the Financial Advisory and Intermediary Services Act 37 of 2002 or an approved credit provider in terms of the National Credit Act of 2005
- b) Bidders who intend to cede their rights to payment to an institution as prescribed in 7.1 attach cession agreement with their bid proposal.

## 9 JOINT VENTURES

- a) Should this bid be submitted by a joint venture, the joint venture agreement must accompany the bid document before the closing date and time of bid. The joint venture agreement must clearly specify the percentage of the contract to be undertaken by each company participating therein.
- b) **Each party to a Joint Venture/ Consortium must submit separate SBD4 Forms together with the bid before the closing date and time of bid.**
- c) The joint venture or consortium must submit a formal agreement that outlines the roles and responsibilities of each member of the joint venture or consortium, nomination of an authorized person to represent the joint venture or consortium in all matters relating to this bid and the details of the bank account for payments to be affected.
- d) The joint venture or consortium must comply with Central Suppliers Database (CSD) registration requirements as per National Treasury directive.

## 10 UNSATISFACTORY PERFORMANCE

- a) Unsatisfactory performance occurs when performance is not in accordance with the contract conditions.
- b) The departmental official shall warn the contractor in writing that action will be taken in accordance with the contract conditions unless the contractor complies with the contract conditions and delivers satisfactory supplies or services within a specified reasonable time (7 days minimum). If the contractor does not perform satisfactorily despite the warning, the official will:
  - Take action in terms of its delegated powers; and
  - Make a recommendation to the Accounting Officer for cancellation of the contract concerned.
- c) When correspondence is addressed to the contractor, reference will be made to the contract number/item number/s and an explanation of the complaint.

## 11 VALIDITY PERIOD OF BID AND EXTENSION THEREOF

The validity (binding) period for the bid will be 120 days from close of bid. However, circumstances may arise whereby the department may request bidders to extend the validity (binding) period. Should this occur, the department will request bidders to extend the validity (binding) period under the same terms and conditions as originally offered by bidders. This request will be done before the expiry of the original validity (binding) period.

## 12 IRREGULARITIES

Companies are encouraged to advise the Department of Agriculture and Rural Development timeously of any possible irregularities which might come to their notice in connection with this or other contracts.

## 13 NEGOTIATIONS

Bidders should note that the department might subject the successful bidder to negotiations for fair market related prices.

## 14 LANGUAGE GOVERNANCE

The contract shall be written in English. All correspondence and other documents pertaining to the contract that is exchanged by the parties shall also be written in English.

## 15 LAW TO APPLY

The Contract shall in all respects be construed in accordance with the law of the Republic of South Africa, and any difference that may arise with the law of the Republic of South Africa, and any difference that may arise between the Province and the Contractor in regard to the Contract, shall be settled in the Republic of South Africa.

## 16 PENALTIES

Subject to GCC Clause 4, if the Contractor fails to deliver any or all of the goods or to perform the services within the period(s) specified in the contract, the Province shall, without prejudice to its other remedies under the contract, deduct from the contract price, as a penalty, a sum calculated on the delivered price of delayed goods or unperformed services, using the current prime interest rate calculated for each day of the delay until actual delivery or performance. The province may also consider termination of the contract in terms of the GCC.

## 17 COMPLETION OF BID DOCUMENT

The following are minimum requirements for completion of the bid document: -

- a) Bidders are required to complete the entire bid document in terms of the requirements contained herein.
- b) Where the space provided in the bid document is insufficient, separate schedules may be drawn up in accordance with the given formats. These schedules shall then be bound together with suitable contents page and submitted with the bid documents.
- c) All bid documents, certificates, schedules (including additional schedules as mentioned above) and all forms required by this bid must be completed in black ink and signed by the authorized signatory.
- d) Bid document should be returned in the provided sequence.
- e) Bidders must ensure that there are no missing or duplicated pages. LDARD shall not accept liability regarding claims by bidders that pages are missing or duplicated.
- f) Correction fluid is not allowed and any cancellation, alteration or amendment on the bid document must be signed for by the authorized signatory.
- g) Completed bid document with supporting documents shall be packaged, bound, sealed, marked, and submitted strictly as stipulated in this bid document.



## T1.3: Annex F: Standard Conditions of Tender

### (As contained in Annexure F of South African National Standard: Construction procurement processes, Methods and procedures: SANS 294: 2004 Edition)

#### F.1 General

##### F.1.1 Actions

The employer and each tenderer submitting a tender offer shall comply with these conditions of tender. In their dealings with each other, they shall discharge their duties and obligations as set out in F.2 and F.3, timeously and with integrity, and behave equitably, honestly and transparently.

##### F.1.2 Tender Documents

The documents issued by the employer for the purpose of a tender offer are listed in the tender data.

##### F.1.3 Interpretation

**F.1.3.1** The tender data and additional requirements contained in the tender schedules that are included in the returnable documents are deemed to be part of these conditions of tender.

**F.1.3.2** These conditions of tender, the tender data and tender schedules which are only required for tender evaluation purposes, shall not form part of any contract arising from the invitation to tender.

**F.1.3.3** For the purposes of these conditions for the calling for expressions of interest, the following definitions apply:

- a) **comparative offer** means the tenderer's financial offer after the factors of non-firm prices, all unconditional discounts and any other tendered parameters that will affect the value of the financial offer have been taken into consideration
- b) **corrupt practice** means the offering, giving, receiving or soliciting of anything of value to influence the action of the employer or his staff or agents in the tender process; and
- c) **fraudulent practice** means the misrepresentation of the facts in order to influence the tender process or the award of a contract arising from a tender offer to the detriment of the employer, including collusive practices intended to establish prices at artificial levels
- d) **quality (functionality)** means the totality of features and characteristics of a product or service that bear on its ability to satisfy stated or implied needs

##### F.1.4 Communication and employer's agent

Each communication between the employer and a tenderer shall be to or from the employer's agent only, and in a form that can be read, copied and recorded. Writing shall be in the English language. The employer shall not take any responsibility for non-receipt of communications from or by a tenderer. The name and contact details of the employer's agent are stated in the tender data.

##### F.1.5 The employer's right to accept or reject any tender offer

**F.1.5.1** The employer may accept or reject any variation, deviation, tender offer, or alternative tender offer, and may cancel the tender process and reject all tender offers at any time before the formation of a contract. The employer shall not accept or incur any liability to a tenderer for such cancellation and rejection, but will give written reasons for such action.

**F.1.5.2** After the cancellation of a tender process or the rejection of all tender offers the employer may abandon the proposed procurement and re-issue a similar tender notice and invitation to tender not less than three months after the closing dated for tender offers or have it performed in another manner at any time.

#### F.2 Tenderer's obligations

**The tenderer shall comply with the following obligations:**

##### F.2.1 Eligibility

Submit a tender offer only if the tenderer complies with the criteria stated in the tender data and the tenderer, or any of his principals, is not under any restriction to do business with employer.

## **F.2.2 Cost of tendering**

Accept that the employer will not compensate the tenderer for any costs incurred in the preparation and submission of a tender offer, including the costs of any testing necessary to demonstrate that aspects of the offer satisfy requirements.

## **F.2.3 Check documents**

Check the tender documents on receipt for completeness and notify the employer of any discrepancy or omission.

## **F.2.4 Confidentiality and copyright of documents**

Treat as confidential all matters arising in connection with the tender. Use and copy the documents issued by the employer only for the purpose of preparing and submitting a tender offer in response to the invitation.

## **F.2.5 Reference documents**

Obtain, as necessary for submitting a tender offer, copies of the latest versions of standards, specifications, conditions of contract and other publications, which are not attached but which are incorporated into the tender documents by reference.

## **F.2.6 Acknowledge addenda**

Acknowledge receipt of addenda to the tender documents, which the employer may issue, and if necessary apply for an extension to the closing time stated in the tender data, in order to take the addenda into account.

## **F.2.7 Clarification meeting**

Attend, where required, a clarification meeting at which tenderers may familiarize themselves with aspects of the proposed work, services or supply and raise questions. Details of the meeting(s) are stated in the tender data.

## **F.2.8 Seek clarification**

Request clarification of the tender documents, if necessary, by notifying the employer at least five working days before the closing time stated in the tender data.

## **F.2.9 Insurance**

Be aware that the extent of insurance to be provided by the employer (if any) may not be for the full cover required in terms of the conditions of contract identified in the contract data. The tenderer is advised to seek qualified advice regarding insurance.

## **F.2.10 Pricing the tender offer**

**F.2.10.1** Include in the rates, prices, and the tendered total of the prices (if any) all duties, taxes (except Value Added Tax (VAT)), and other levies payable by the successful tenderer, such duties, taxes and levies being those applicable 14 days before the closing time stated in the tender data.

**F.2.10.2** Show VAT payable by the employer separately as an addition to the tendered total of the prices.

**F.2.10.3** Provide rates and prices that are fixed for the duration of the contract and not subject to adjustment except as provided for in the conditions of contract identified in the contract data.

**F.2.10.4** State the rates and prices in Rand unless instructed otherwise in the tender data. The conditions of contract identified in the contract data may provide for part payment in other currencies.

## **F.2.11 Alterations to documents**

Not make any alterations or additions to the tender documents, except to comply with instructions issued by the employer, or necessary to correct errors made by the tenderer. All signatories to the tender offer shall initial all such alterations. Erasures and the use of masking fluid are prohibited.

## **F.2.12 Alternative tender offers**

**F.2.12.1** Submit alternative tender offers only if a main tender offer, strictly in accordance with all the requirements of the tender documents, is also submitted. The alternative tender offer is to be submitted with the main tender offer together with a schedule that compares the requirements of the tender documents with the alternative requirements the tenderer proposes.

**F.2.12.2** Accept that an alternative tender offer may be based only on the criteria stated in the tender data or criteria otherwise acceptable to the employer.

## **F.2.13 Submitting a tender offer**

**F.2.13.1** Submit a tender offer to provide the whole of the works, services or supply identified in the contract data and described in the scope of works, unless stated otherwise in the tender data.

**F.2.13.2** Return all returnable documents to the employer after completing them in their entirety, either electronically (if they were issued in electronic format) or by writing in black ink.

**F.2.13.3** Submit the parts of the tender offer communicated on paper as an original plus the number of copies stated in the tender data, with an English translation of any documentation in a language other than English, and the parts communicated electronically in the same format as they were issued by the employer.

**F.2.13.4** Sign the original and all copies of the tender offer where required in terms of the tender data. The employer will hold all authorized signatories liable on behalf of the tenderer. Signatories for tenderers proposing to contract as joint ventures shall state which of the signatories is the lead partner whom the employer shall hold liable for the purpose of the tender offer.

**F.2.13.5** Seal the original and each copy of the tender offer as separate packages marking the packages as "ORIGINAL" and "COPY". Each package shall state on the outside the employer's address and identification details stated in the tender data, as well as the tenderer's name and contact address.

**F.2.13.6** Where a two-envelope system is required in terms of the tender data, place and seal the returnable documents listed in the tender data in an envelope marked "financial proposal" and place the remaining returnable documents in an envelope marked "technical proposal". Each envelope shall state on the outside the employer's address and identification details stated in the tender data, as well as the tenderer's name and contact address.

**F.2.13.7** Seal the original tender offer and copy packages together in an outer package that states on the outside only the employer's address and identification details as stated in the tender data.

**F.2.13.8** Accept that the employer shall not assume any responsibility for the misplacement or premature opening of the tender offer if the outer package is not sealed and marked as stated.

#### **F.2.14 Information and data to be completed in all respects**

Accept that tender offers, which do not provide all the data or information requested completely and in the form required, may be regarded by the employer as non-responsive.

#### **F.2.15 Closing time**

**F.2.15.1** Ensure that the employer receives the tender offer at the address specified in the tender data not later than the closing time stated in the tender data. Proof of posting shall not be accepted as proof of delivery. The employer shall not accept tender offers submitted by telegraph, telex, facsimile or e-mail, unless stated otherwise in the tender data.

**F.2.15.2** Accept that, if the employer extends the closing time stated in the tender data for any reason, the requirements of these conditions of tender apply equally to the extended deadline.

#### **F.2.16 Tender offer validity**

**F.2.16.1** Hold the tender offer(s) valid for acceptance by the employer at any time during the validity period stated in the tender data after the closing time stated in the tender data.

**F.2.16.2** If requested by the employer, consider extending the validity period stated in the tender data for an agreed additional period.

#### **F.2.17 Clarification of tender offer after submission**

Provide clarification of a tender offer in response to a request to do so from the employer during the evaluation of tender offers. This may include providing a breakdown of rates or prices and correction of arithmetical errors by the adjustment of certain rates or item prices (or both). No change in the total of the prices or substance of the tender offer is sought, offered, or permitted. The total of the prices stated by the tenderer shall be binding upon the tenderer.

**Note:** Sub-clause F.2.17 does not preclude the negotiation of the final terms of the contract with a preferred tenderer following a competitive selection process, should the Employer elect to do so.

#### **F.2.18 Provide other material**

**F.2.18.1** Provide, on request by the employer, any other material that has a bearing on the tender offer, the tenderer's commercial position (including notarized joint venture agreements), preferencing arrangements, or samples of materials, considered necessary by the employer for the purpose of a full and fair risk assessment. Should the tenderer not provide the material, or a satisfactory reason as to why it cannot be provided, by the time for submission stated in the employer's request, the employer may regard the tender offer as non-responsive.

**F.2.18.2** Dispose of samples of materials provided for evaluation by the employer, where required.

### **F.2.19 Inspections, tests and analysis**

Provide access during working hours to premises for inspections, tests and analysis as provided for in the tender data.

### **F.2.20 Submit securities, bonds, policies, etc.**

If requested, submit for the employer's acceptance before formation of the contract, all securities, bonds, guarantees, policies and certificates of insurance required in terms of the conditions of contract identified in the contract data.

### **F.2.21 Check final draft**

Check the final draft of the contract provided by the employer within the time available for the employer to issue the contract.

### **F.2.22 Return of other tender documents**

If so instructed by the employer, return all retained tender documents within 28 days after the expiry of the validity period stated in the tender data.

### **F.2.23 Certificates**

Include in the tender submission or provide the employer with any certificates as stated in the tender data.

## **F.3 The employer's undertakings**

### **The employer undertakes to:**

#### **F.3.1 Respond to clarification**

Respond to a request for clarification received up to five working days prior to the tender closing time stated in the Tender Data and notify all tenderers who drew procurement documents.

#### **F.3.2 Issue Addenda**

If necessary, issue addenda that may amend or amplify the tender documents to each tenderer during the period from the date of the Tender Notice until seven days before the tender closing time stated in the Tender Data. If, as a result a tenderer applies for an extension to the closing time stated in the Tender Data, the Employer may grant such extension and, will then notify it to all tenderers who drew documents.

#### **F.3.3 Return late tender offers**

Return tender offers received after the closing time stated in the Tender Data, unopened, (unless it is necessary to open a tender submission to obtain a forwarding address), to the tenderer concerned.

#### **F.3.4 Opening of tender submissions**

**F.3.4.1** Unless the two-envelope system is to be followed, open valid tender submissions in the presence of tenderers' agents who choose to attend at the time and place stated in the tender data. Tender submissions for which acceptable reasons for withdrawal have been submitted will not be opened.

**F.3.4.2** Announce at the opening held immediately after the opening of tender submissions, at a venue indicated in the tender data, the name of each tenderer whose tender offer is opened, the total of his prices, preferences claimed and time for completion, if any, for the main tender offer only.

**F.3.4.3** Make available the record outlined in F.3.4.2 to all interested persons upon request.

#### **F.3.5 Two-envelope system**

**F.3.5.1** Where stated in the tender data that a two-envelope system is to be followed, open only the technical proposal of valid

tenders in the presence of tenderers' agents who choose to attend at the time and place stated in the tender data and announce the name of each tenderer whose technical proposal is opened.

**F.3.5.2** Evaluate the quality of the technical proposals offered by tenderers, then advise tenderers who remain in contention for the award of the contract of the time and place when the financial proposals will be opened. Open only the financial proposals of tenderers, who score in the quality evaluation above the minimum number of points for quality stated in the tender data, and announce the score obtained for the technical proposals and the total price and any preferences claimed. Return unopened financial proposals to tenderers whose technical proposals failed to achieve the minimum number of points for quality.

### **F.3.6 Non-disclosure**

Not disclose to tenderers, or to any other person not officially concerned with such processes, information relating to the evaluation and comparison of tender offers, the final evaluation price and recommendations for the award of a contract, until after the award of the contract to the successful tenderer.

### **F.3.7 Grounds for rejection and disqualification**

Determine whether there has been any effort by a tenderer to influence the processing of tender offers and instantly disqualify a tenderer (and his tender offer) if it is established that he engaged in corrupt or fraudulent practices.

### **F.3.8 Test for responsiveness**

Determine, on opening and before detailed evaluation, whether each tender offer properly received:

- a) meets the requirements of these Conditions of Tender,
- b) has been properly and fully completed and signed, and
- c) is responsive to the other requirements of the tender documents.

A responsive tender is one that conforms to all the terms, conditions, and specifications of the tender documents without material deviation or qualification. A material deviation or qualification is one which, in the Employer's opinion, would:

- detrimentally affect the scope, quality, or performance of the works, services or supply identified in the Scope of Work,
- change the Employer's or the tenderer's risks and responsibilities under the contract, or
- affect the competitive position of other tenderers presenting responsive tenders, if it were to be rectified.

Reject a non-responsive tender offer, and not allow it to be subsequently made responsive by correction or withdrawal of the non-conforming deviation or reservation.

### **F.3.9 Arithmetical errors**

Check responsive tender offers for arithmetical errors, correcting them in the following manner:

- Where there is a discrepancy between the amounts in figures and in words, the amount in words shall govern.
- If a bill of quantities (or schedule of rates) apply and there is an error in the line item total resulting from the product of the unit rate and the quantity, the line item total shall govern and the rate shall be corrected. Where there is an obviously gross misplacement of the decimal point in the unit rate, the line item total as quoted shall govern, and the unit rate will be corrected.
- Where there is an error in the total of the prices either as a result of other corrections required by this checking process or in the tenderer's addition of prices, the total of the prices shall govern and the tenderer will be asked to revise selected item prices (and their rates if a bills of quantities applies) to achieve the tendered total of the prices.

Consider the rejection of a tender offer if the tenderer does not correct or accept the correction of his arithmetical errors in the manner described above.

### **F.3.10 Clarification of a tender offer**

Obtain clarification from a tenderer on any matter that could give rise to ambiguity in a contract arising from the tender offer.

### **F.3.11 Evaluation of tender offers**

#### **F.3.11.1 General**

Appoint an evaluation panel of not less than three persons. Reduce each responsive tender offer to a comparative offer and evaluate it using the tender evaluation method that is indicated in the Tender Data and described below:

Method 1: Financial offer	1) Rank tender offers from the most favorable to the least favorable comparative offer. 2) Recommend highest ranked tenderer for the award of the contract, unless there are compelling and justifiable reasons not to do so.
Method 2: Financial offer and preferences	1) Score tender evaluation points for financial offer. 2) Confirm that tenderers are eligible for the preferences claimed and if so, score tender evaluation points for preferencing. 3) Calculate total tender evaluation points. 4) Rank tender offers from the highest number of tender evaluation points to the lowest. 5) Recommend tenderer with the highest number of tender evaluation points for the award of the contract, unless there are compelling and justifiable reasons not to do so.
Method 3: Financial offer and quality	1) Score quality, rejecting all tender offers that fail to score the minimum number of points for quality stated in the Tender data. 2) Score tender evaluation points for financial offer. 3) Calculate total tender evaluation points. 4) Rank tender offers from the highest number of tender evaluation points to the lowest. 5) Recommend tenderer with the highest number of tender evaluation points for the award of the contract, unless there are compelling and justifiable reasons not to do so.
Method 4: Financial offer, quality and preferences	1) Score quality, rejecting all tender offers that fail to score the minimum number of points for quality stated in the Tender data. 2) Score tender evaluation points for financial offer. 3) Confirm that tenderers are eligible for the preferences claimed, and if so, score tender evaluation points for preferencing. 4) Calculate total tender evaluation points. 5) Rank tender offers from the highest number of tender evaluation points to the lowest. 6) Recommend tenderer with the highest number of tender evaluation points for the award of the contract, unless there are compelling and justifiable reasons not to do so.

Score financial offers, preferences and quality, as relevant, to two decimal places.

**F.3.11.2 Scoring Financial Offers**

Score the financial offers of remaining responsive tender offers using the following formula:

$N_{FO} = W_1 \times A$  where:

$N_{FO}$  = the number of tender evaluation points awarded for the financial offer.

$W_1$  = the maximum possible number of tender evaluation points awarded for the financial offer as stated in the Tender Data.

$A$  = a number calculated using either formulas 1 or 2 below as stated in the Tender Data.

Formula	Comparison aimed at achieving	Option 1	Option 2
1	Highest price or discount	$A = (1 + \frac{P - P_m}{P_m})$	$A = P / P_m$
2	Lowest price or percentage commission / fee	$A = (1 - \frac{P - P_m}{P_m})$	$A = P_m / P$

where:

$P_m$  = the comparative offer of the most favorable tender offer.

$P$  = the comparative offer of tender offer under consideration.

**F.3.11.3 Scoring quality (functionality)**

Score quality in each of the categories stated in the Tender Data and calculate total score for quality.

**F.3.12 Insurance provided by the employer**

If requested by the proposed successful tenderer, submit for the tenderer's information the policies and / or certificates of insurance which the conditions of contract identified in the contract data, require the employer to provide.

**F.3.13 Acceptance of tender offer**

**F.3.13.1** Accept tender offer only if the tenderer satisfies the legal requirements stated in Clause F.2.1 of the Tender Data.

**F.3.13.2** Notify the successful tenderer of the employer's acceptance of his tender offer by completing and returning one copy of the form of offer and acceptance before the expiry of the validity period stated in the tender data, or agreed additional period. Providing the form of offer and acceptance does not contain any qualifying statements, it will constitute the formation of a contract between the employer and the successful tenderer as described in the form of offer and acceptance.

**F.3.14 Notice to unsuccessful tenderers**

After the successful tenderer has acknowledged the employer's notice of acceptance, notify other tenderers that their tender offers have not been accepted.

**F.3.15. Prepare contract documents**

If necessary, revise documents that shall form part of the contract and that were issued by the employer as part of the tender documents to take account of:

- a) addenda issued during the tender period,
- b) inclusion of some of the returnable documents,
- c) other revisions agreed between the employer and the successful tenderer, and
- d) the schedule of deviations attached to the form of offer and acceptance, if any.

**F.3.16 Issue final contract**

Prepare and issue the final draft of contract documents to the successful tenderer for acceptance as soon as possible after the date of the employer's signing of the form of offer and acceptance (including the schedule of deviations, if any). Only those documents that the conditions of tender require the tenderer to submit, after acceptance by the employer, shall be included.

**F.3.17 Complete adjudicator's contract**

Unless alternative arrangements have been agreed or otherwise provided for in the contract, arrange for both parties to complete formalities for appointing the selected adjudicator at the same time as the main contract is signed.

**F.3.18 Provide copies of the contracts**

Provide to the successful tenderer the number of copies stated in the Tender Data of the signed copy of the contract as soon as possible after completion and signing of the form of offer and acceptance.

---

## PART T2: RETURNABLE SCHEDULES

<b>TABLE OF CONTENTS</b>	<b>Page</b>	<b>Colour</b>
<b>T2.1: LIST OF RETURNABLE DOCUMENTS.....</b>	T.23	Yellow
<b>T2.2: RETURNABLE SCHEDULES TO BE COMPLETED BY TENDERER .....</b>	T.24	Yellow



## T2.1 List of Returnable Documents

The Tenderer must complete the following Returnable Documents:

### 1 Returnable Schedules required only for Tender Evaluation purposes

- B: Record of Addenda to Tender Documents
- C: Certificate of Authority for Joint Ventures / Close Corporation/ Partnership/ Company/ Sole Proprietor (Certified copies of Identity Documents for all members of Joint Ventures / Close Corporation / Partnership / Company / Sole Proprietor)
- D: Registration Certificates of entities – Joint Ventures / Close Corporation/ Partnership/ Company/ Sole Proprietor
- E: Compulsory Enterprise Questionnaire
- F: Schedule of the Tenderer's Experience
- G: Schedule of Key Personnel
- H: Format of Curriculum Vitae
- I: Proposed Amendments, Qualifications and Alternatives
- J: Schedule of Subcontractors
- K: Schedule of Plant and Equipment available for this contract
- L: Copy of the Workmen's Compensation Registration Certificate (or proof of payment of contributions in terms of the Compensation for Occupational Injuries and Diseases Act No. 130 of 1993)
- M: Company profile, including track record
- N: Construction Industries Development Board (CIDB) Registration – **4CE/ME or higher**.

### 2 Other Documents required only for Tender Evaluation purposes

- P: Financial Standing – Attach Letter of Intent

### 3 Returnable Schedules that will be incorporated into the Contract

- Q: Preferencing Schedule (Direct Preferences) – SBD Forms
- R: Other SBD Forms (SBD1, SBD3.1, SBD4, SBD 6.1)
- S: Execution Programme/ Program of Works
- T: Detailed Method Statement
- U: Contractor's Health and Safety Declaration

### 4 Other Documents that will be incorporated into the Contract

- V: Contractor's Safety Plan
- W: Proforma Notification form in terms of the Occupational Health and Safety Act 1993, Construction Regulations, 2003
- X: Monthly Labour Report

### 5 The Offer portion

- Part C1 Agreement and Contract Data
- Part C2 Pricing Data
- Part C3 Scope of Work
- Part C4 Site Information

**ANNEXURE A: BIDDER'S DETAILED EXPERIENCE REPORT – REFERENCE SHEETS (Duplicate the reference sheet for more reference reports)**

---

## **T2.2 Returnable Schedules to be completed by Tenderer**

---

### A. CERTIFICATE OF ATTENDANCE AT A TENDER SITE MEETING

This is to certify that (*Tenderer*) .....

of (*address*).....

..... was represented by the person(s) named below at the compulsory meeting held for all Tenderers at **Royal field project that is located in Manenzhe village, 130 km outside Musina town, in the Musina local municipality, having GPS coordinates 22°27'13.05"S 30°30'7.65"E** for Tender No **ACDP 23/05** on **15 January 2024** at **10:00**.

I / We acknowledge that the purpose of the meeting was to acquaint myself / ourselves with the Site of the Works and / or matters incidental to doing the Work specified in the Tender Documents in order for me / us to take account of everything necessary when compiling our rates and prices included in the Tender.

**Particulars of person(s) attending the meeting:**

Name: ..... Signature: .....

Capacity: .....

Name: ..... Signature: .....

Capacity: .....

**Attendance of the above person(s) at the meeting is confirmed by the Employer's representative, namely:**

Name: ..... Signature: .....

Capacity: ..... Date and Time: .....

**B. RECORD OF ADDENDA TO TENDER DOCUMENTS**

We confirm that the following communications received from the Employer before the submission of this Tender Offer, amending the Tender Documents, have been taken into account in this Tender Offer:		
1.		
1.		
2.		
3.		
4.		
5.		

Attach additional pages if more space is required.

Signed..... Date.....

Name..... Position.....

Tenderer.....

**C. CERTIFICATE OF AUTHORITY OF AN ENTITY**

Indicate the status of the Tenderer by ticking the appropriate box hereunder. The Tenderer must complete the Certificate set out below for the relevant category.

(I) Company	(II) Close Corporation	(III) Partnership	(IV) Joint Venture	(V) Sole Proprietor

**(I) CERTIFICATE FOR COMPANY**

I ....., chairperson of the Board of Directors of  
 ....., hereby confirm that by resolution of the Board (copy  
 attached) taken on ..... 20.....,

Mr/Ms ....., acting in the capacity of  
 ....., was authorised to sign all Documents in  
 connection with this Tender and any Contract resulting from it on behalf of the Company.

**Signature of Chairman:** .....

**Signature of Signatory:** .....

**As Witnesses:**

1..... Name in Block Letters.....

2..... Name in Block Letters.....

**Date:** .....

**(II) CERTIFICATE FOR CLOSE CORPORATION**

We, the undersigned, being the key Members in the business trading as.....  
 ..... hereby authorise Mr/Ms .....,  
 acting in the capacity of ....., to sign all Documents  
 in connection with the Tender for Contract No and any Contract resulting from it on our behalf.

**Signature of Signatory:** .....

**As Witnesses:**

1..... Name in Block Letters.....

2..... Name in Block Letters.....

**Date:** .....

NAME	ADDRESS	SIGNATURE	DATE

**Note:** *This Certificate is to be completed and signed by all of the key Members upon whom rests the Direction of the Affairs of the Close Corporation as a whole.*

**(III) CERTIFICATE FOR PARTNERSHIP**

We, the undersigned, being the key Partners in the business trading as,

.....hereby authorise Mr/Ms.....

acting in the capacity of ....., to sign all Documents in connection

with the Tender for Contract No and any Contract resulting from it on our behalf.

**Signature of Signatory:** .....

**As Witnesses:**

1..... Name in Block Letters.....

2..... Name in Block Letters.....

**Date:** .....

NAME	ADDRESS	SIGNATURE	DATE

**Note:** *This Certificate is to be completed and signed by all of the key Partners upon who rests the Direction of the Affairs of the Partnership as a whole.*

**(IV) CERTIFICATE FOR PARTNERSHIP**

We, the undersigned, are submitting this Tender Offer in Joint Venture and hereby authorize Mr/Ms  
 ....., authorized signatory of the Company, .....  
 .....acting in the capacity of Lead Partner, to sign all Documents in connection with the  
 Tender Offer for Contract No and any Contract resulting from it on our behalf.

This authorization is evidenced by the attached power of attorney signed by legally authorized signatories  
 of all the Partners to the Joint Venture.

**Signature of Signatory:** .....

**As Witnesses:**

1..... Name in Block Letters.....

2..... Name in Block Letters.....

**Date:** .....

NAME OF FIRM	ADDRESS	AUTHORISING SIGNATURE, NAME AND CAPACITY
Lead Partner		

**Note:** *This Certificate is to be completed and signed by all of the key Partners upon who rests the Direction of the Affairs of the Partnership as a whole.*



---

**V) CERTIFICATE FOR SOLE PROPRIETOR**

I....., hereby confirm that I am the Sole Owner of the  
  
business trading as:.....

**Signature of Sole Owner:** .....

**As Witnesses:**

1..... Name in Block Letters.....

2..... Name in Block Letters.....

**Date:** .....

---

## D. REGISTRATION CERTIFICATE OF AN ENTITY

***[Important note to Tenderer: Registration Certificates for Companies, Close Corporations, Partnerships and ID Documents for Sole Proprietors must be inserted here. In the case of a Joint Venture, a copy of a duly signed Joint Venture Agreement must be included]***

**E. COMPULSORY ENTERPRISE QUESTIONNAIRE**

The following particulars must be furnished. In the case of a Joint Venture, **separate** Enterprise questionnaires in respect of each Partner must be completed and submitted.

**Section 1: Name of Enterprise:** .....

**Section 2: VAT registration number, if any:** .....

**Section 3: CIDB registration number, if any:** .....

**Section 4: Particulars of Sole Proprietors and Partners in Partnerships**

Name*	Identity number*	Personal income tax number*

\* Complete only if Sole Proprietor or Partnership and attach separate page if more than 3 Partners

**Section 5: Particulars of Companies and Close Corporations**

Company registration number .....

Close Corporation number .....

Tax reference number .....

**Section 6: Record in the service of the State**

Indicate by marking the relevant boxes with a cross, if any Sole Proprietor, Partner in a Partnership or Director, Manager, Principal Shareholder or Stakeholder in a Company or Close Corporation is currently or has been within the last 12 months in the service of any of the following:

- |  |   |
|--|---|
| <input type="checkbox"/> a Member of any Municipal Council                                     | <input type="checkbox"/> an employee of any Provincial Department, National or Provincial Public entity or Constitutional Institution within the meaning of the Public Finance Management Act, 1999 (Act 1 of 1999) |
| <input type="checkbox"/> a Member of any Provincial Legislature                                | <input type="checkbox"/> a Member of an Accounting Authority of any National or Provincial Public Entity  |
| <input type="checkbox"/> a Member of the National Assembly or the National Council of Province | <input type="checkbox"/> an employee of Parliament or a Provincial Legislature  |
| <input type="checkbox"/> a Member of the Board of Directors of any Municipal entity            |   |
| <input type="checkbox"/> an Official of any Municipality or Municipal entity                   |   |

If any of the above boxes are marked, disclose the following:

Name of Sole Proprietor, Partner, Director, Manager, Principal Shareholder or Stakeholder	Name of Institution, Public Office, board or organ of State and position held	Status of service (tick appropriate column)	
		Current	Within last 12 months

\*insert separate page if necessary

**Section 7: Record of spouses, children and parents in the service of the State**

Indicate by marking the relevant boxes with a cross, if any spouse, child or parent of a Sole Proprietor, Partner in a Partnership or Director, Manager, Principal Shareholder or Stakeholder in a Company or Close Corporation is currently or has been within the last 12 months been in the service of any of the following:

- |  |   |
|--|---|
| <input type="checkbox"/> a Member of any Municipal Council                                     | <input type="checkbox"/> an employee of any Provincial Department, National or Provincial Public Entity or Constitutional Institution within the meaning of the Public Finance Management Act, 1999 (Act 1 of 1999) |
| <input type="checkbox"/> a Member of any Provincial Legislature                                | <input type="checkbox"/> a Member of an Accounting Authority of any National or Provincial Public entity  |
| <input type="checkbox"/> a Member of the National Assembly or the National Council of Province | <input type="checkbox"/> an employee of Parliament or a Provincial Legislature  |
| <input type="checkbox"/> a Member of the Board of Directors of any Municipal Entity            |   |
| <input type="checkbox"/> an Official of any Municipality or Municipal entity                   |   |

Name of spouse, child or parent	Name of Institution, Public Office, Board or Organ of State and position held	Status of service (tick appropriate column)	
		Current	Within last 12 months

\*insert separate page if necessary

The undersigned, who warrants that he / she is duly authorised to do so on behalf of the Enterprise:

- i) authorizes the Employer to obtain a tax clearance Certificate from the South African Revenue Services that my / our tax matters are in order;
- ii) confirms that the neither the name of the Enterprise or the name of any Partner, Manager, Director or other Person, who wholly or partly exercises, or may exercise, control over the Enterprise appears on the Register of Tender Defaulters established in terms of the Prevention and Combating of Corrupt Activities Act of 2004;
- iii) confirms that no Partner, Member, Director or other Person, who wholly or partly exercises, or may exercise, control over the Enterprise appears, has within the last five years been convicted of fraud or corruption;
- iv) confirms that I / we are not associated, linked or involved with any other Tendering entities submitting Tender Offers and have no other relationship with any of the Tenderers or those responsible for compiling the Scope of Work that could cause or be interpreted as a conflict of interest; and
- iv) confirms that the contents of this questionnaire are within my personal knowledge and are to the best of my belief both true and correct.

Signed

Date

Name

Position

Enterprise  
Name



**G. KEY PERSONNEL**

In terms of the Project Specification and the Conditions of Tender, unskilled Workers may only be brought in from outside the Local Community if such personnel are not available locally.

**The Tenderer shall list below the personnel which he intends to utilize on the Works, including key personnel which may have to be brought in from outside if not available locally.**

**All technical works must be done by qualified artisans with applicable experience. Bidders must provide curriculum vitae of the key personnel who will be performing the works.**

Category of Employee	Number of Persons		
	Key Personnel, Part of the Contractors Organisation	Key Personnel to be imported if not locally available	Unskilled Personnel to be recruited from the local community
Site Agent/Project Managers, 2 years experience			
Foremen, 2 years experience			
Electrician, 2 years experience			
Plumber, 2 years experience			
Quality Control and Safety Personnel, 2 years experience			
Plant Operators, 2 year experience			

SIGNATURE: .....  
 (of person authorised to sign on behalf of the Tenderer)

DATE: .....













## I. AMENDMENTS, QUALIFICATIONS AND ALTERNATIVES

*(This is not an invitation for amendments, deviations or alternatives, but should the Tenderer desire to make any departures from the Provisions of this Contract he shall set out his proposals clearly hereunder. The Employer will not consider any amendment, unless form (a), has been completed to the satisfaction of the Employer). The Tenderer is referred to Tender Data paragraph F.2.12, where it is clearly stated that no Alternative Offers will be accepted.*

I / We herewith propose the amendments, as set out in the table below:

### (a) AMENDMENTS

PAGE, CLAUSE OR ITEM NO	PROPOSED AMENDMENT

- Notes:**
- (1) Amendments to the General and Special Conditions of Contract are not acceptable;
  - (2) The Tenderer must give full details of all the financial implications of the amendments and qualifications in a covering letter attached to his Tender.

**J. SCHEDULE OF PROPOSED SUB-CONTRACTORS**

We notify you that it is our intention to employ the following Subcontractors for Work in this Contract.

If we are awarded a Contract we agree that this notification does not change the requirement for us to submit the names of proposed Subcontractors in accordance with requirements in the Contract for such appointments. If there are no such requirements in the Contract, then your written acceptance of this list shall be binding between us.

We confirm that all Subcontractors who are Contracted to construct a house are registered as Home Builders with the National Home Builders Registration Council.

	<b>Name and address of proposed Subcontractor</b>	<b>Nature and extent of Work</b>	<b>Previous experience with Subcontractor.</b>
1.			
2.			
3.			
4.			
5.			

Signed

Date

Name

Position

Tenderer

**K. SCHEDULE OF PLANT AND EQUIPMENT**

The following are lists of major items of relevant equipment that I / we presently own or lease and will have available for this Contract or will acquire or hire for this Contract if my / our Tender is accepted.

(a) Details of major equipment that is owned by and immediately available for this Contract.

Quantity	Description, size, capacity, etc.

Attach additional pages if more space is required.

(b) Details of major equipment that will be hired, or acquired for this Contract if my / our Tender is acceptable.

Quantity	Description, size, capacity, etc.

Attach additional pages if more space is required.

Signed

Date

Name

Position

Tenderer

**Proof of ownership and/or rental agreement should form part of tender document.**

---

**L. COPY OF WORKMEN'S COMPENSATION REGISTRATION CERTIFICATE (OR PROOF OF  
PAYMENT OF CONTRIBUTIONS IN TERMS OF THE COMPENSATION FOR OCCUPATIONAL  
INJURIES AND DISEASES ACT NO. 130 OF 1993)**

*[Certified Copy of the Certificate or Proof of Payment thereof obtained from the Workmen's  
Compensation Commissioner to be inserted here]*

---

**M. COMPANY PROFILE, INCLUDING TRACK RECORD**

***[Abbreviated company profile, giving history, status, activities, staff and track record of the tendering entity, to be inserted here. In case of a Joint Venture, a separate profile for each partner must be submitted]***



---

**N. CONSTRUCTION INDUSTRIES DEVELOPMENT BOARD (CIDB) REGISTRATION**

***[Certified copy of the Tenderer's CIDB registration indicating the Contractor grading designation, to be inserted here. For a Joint Venture, each partner's CIDB certificate is to be included, as applicable].***

***NOT A REQUIREMENT***

---

## O. TAX COMPLIANCE STATUS

### IMPORTANT NOTES:

1. The Central Supplier Database and tax compliance status PIN are approved methods that will be used to verify tax compliance as SARS does not issue tax clearance certificate any more but has made an online provision available via eFiling for bidders to print their own tax clearance certificates which can be submitted with this bid.
2. Tax Clearance submitted by bidders will be verified on eFiling and/or Central Supplier database.
3. Bidders must provide a tax compliance status PIN and Central Supplier Database Number to access their records and verify tax compliance status

**APPLICATION FORM FOR TAX CLEARANCE CERTIFICATE**

*(In respect of Tender see note at bottom)*

1. NAME OF TAXPAYER/TENDERER:.....

2. TRADE NAME:  
.....

3. IDENTIFICATION No. (if applicable):.....

4. COMPANY/CLOSE CORPORATION REG No:.....

5. INCOME TAX REFERENCE No:.....

6. VAT REGISTRATION No:.....

7. PAYE EMPLOYERS REG No. (if applicable)  
:.....

**NB: Copy of the Tender request must be attached to this application.**

CONTACT PERSON REQUIRING TAX CLEARANCE CERTIFICATE:

SIGNATURE: .....

NAME : .....

TELEPHONE NUMBER : CODE: ..... NUMBER:  
.....

ADDRESS :  
.....  
.....

DATE : 20...../...../.....

Please note that the Commissioner for the South African Revenue Service (SARS) will not exercise his discretionary powers in favour of any person with regard to any interest, penalties and/or additional tax leviable due to the late or underpayment of taxes, duties or levies or the rendition of returns by any person.

NAME OF PERSON RESPONSIBLE FOR CONTRACT:  
.....

(ST 5.1) March 1999

**NB: This is a pro forma application form that has to be submitted to SARS to enable them to issue the required Tax Clearance Certificate. The original and valid Tax Clearance Certificate furnished by the Receiver of Revenue must be submitted with the Tender (to be attached to the next page).**

---

## **TAX CLEARANCE CERTIFICATE**

***[Valid Original Tax Clearance Certificate obtained from SARS to be inserted here after OR CSD SUMMARY]***

---

## P. TENDERER'S FINANCIAL STANDING

In terms of Clause F.2.18.1 of the Contract-specific Tender Data the Tenderer shall provide information about his commercial position, which includes information necessary for the Employer to evaluate the Tenderer's financial standing.

To that end the Tenderer must provide with his tender a bank rating, certified by his banker, to the effect that he will be able to successfully complete the contract at the tendered amount within the specified time for completion.

However, should the Tenderer be unable to provide a bank rating with his tender, he shall state the reasons as to why he is unable to do so, and in addition provide the following details of his banker and bank account that he intends to use for project:

Name of account holder:.....

Name of Bank: .....

Branch: .....

Account number: .....

Type of account: .....

Telephone number: .....

Facsimile number: .....

Name of contact person (at bank):.....

**Failure to provide either the required bank details or a certified bank rating with his tender, will lead to the conclusion that the Tenderer does not have the necessary financial resources at his disposal to complete the contract successfully within the specified time for completion.**

The Employer undertakes to treat the information thus obtained as confidential, strictly for the use of evaluation of the tender submitted by the Tenderer.

SIGNATURE: ..... DATE: .....  
(of person authorised to sign on behalf of the Tenderer)

---

### P1 FINANCIAL INFORMATION OF TENDERER

This information sheet has to be filled in by the financier of the Tenderer, duly signed and stamped on behalf of the financial institution he represents.

#### Tenderer / Tender Details

Tender Description:

.....

Contract Period:

.....

Name of Tenderer:

.....

Bank Account Number:

.....

Tender Amount:

.....

Demand Guarantee will be provided by this Bank:      YES       NO

If yes, state amount of Demand Guarantee:

R.....

#### Financial Institution

Name of Commercial Bank:

.....

Branch:

.....

Name of Bank Manager:

.....

Telephone Number:

.....

We acting on behalf of the above Commercial Bank confirm that

..... (Tenderer)

has operated an account with us for the last ..... years.

We have been requested to provide a bank rating based in relation to the financial capability of

the Tenderer, taking into account directives set out in the following two tables.

**FINANCIAL CAPABILITY**

Maximum value of contract that the Tenderer is considered capable of	Value on which Bank Rating must be used
Up to R300 000	R24 000
R1 000 000	R78 000
R3 000 000	R240 000
R5 000 000	R480 000
R10 000 000	R900 000
R30 000 000	R2 400 000
R100 000 000	R7 800 000

**BANK RATING**

Bank Code	Description of Bank Code
A	Undoubted for the amount of enquiry
B	Good for the amount of enquiry
C	Good for the amount quoted if strictly in the way of business
D	Fair trade risk for amount of enquiry
E	Figures considered too high
F	Financial position unknown
G	Occasional dishonours
H	Frequent dishonours

The value on which our Bank Rating of the Tenderer is based is R.....

In words ..... only)

**The Bank Rating is code:** .....

.....  
 .....

Signature: Manager Financial Institution

.....

Print Name

Date

**RUBBER STAMP OF INSTITUTION**



---

**Q: OTHER SBD FORMS REQUIRED TO BE COMPLETED**

**SBD1 - Invitation to Bid (Version 1 of 2023)**

**SBD 3.1 – Pricing Schedule – Firm Price**

**SBD 4 – Bidders Disclosure.**

**SBD 6.1 - Preference Point Claim Form**



**SBD1**

**PART A  
 INVITATION TO BID**

<b>YOU ARE HEREBY INVITED TO BID FOR REQUIREMENTS OF THE (LIMPOPO DEPARTMENT OF AGRICULTURE AND RURAL DEVELOPMENT)</b>					
BID NUMBER:	<b>ACDP 23/05</b>	CLOSING DATE:	<b>22 JANUARY 2024</b>	CLOSING TIME:	<b>11:00</b>
DESCRIPTION	<b>CONSTRUCTION OF CHILI PEPPER DRYING FACILITY AT ROYAL FIELD FARM UNDER MUSINA LOCAL MUNICIPALITY IN VHEMBE DISTRICT OF LIMPOPO PROVINCE</b>				
<b>BID RESPONSE DOCUMENTS MAY BE DEPOSITED IN THE BID BOX SITUATED AT (STREET ADDRESS)</b>					
<b>67/69 BICCARD STREET DEPARTMENT</b>					
<b>DEPARTMENT OF AGRICULTURE AND RURAL DEVELOPMENT</b>					
<b>POLOKWANE</b>					
<b>0699</b>					
<b>BIDDING PROCEDURE ENQUIRIES MAY BE DIRECTED TO</b>			<b>TECHNICAL ENQUIRIES MAY BE DIRECTED TO:</b>		
CONTACT PERSON		CONTACT PERSON			
TELEPHONE NUMBER		TELEPHONE NUMBER			
FACSIMILE NUMBER		FACSIMILE NUMBER			
E-MAIL ADDRESS		E-MAIL ADDRESS			
<b>SUPPLIER INFORMATION</b>					
NAME OF BIDDER					
POSTAL ADDRESS					
STREET ADDRESS					
TELEPHONE NUMBER	CODE		NUMBER		
CELLPHONE NUMBER					
FACSIMILE NUMBER	CODE		NUMBER		
E-MAIL ADDRESS					
VAT REGISTRATION NUMBER					
SUPPLIER COMPLIANCE STATUS	TAX COMPLIANCE SYSTEM PIN:		<b>OR</b>	CENTRAL SUPPLIER DATABASE No:	MAAA
ARE YOU THE ACCREDITED REPRESENTATIVE IN SOUTH AFRICA FOR THE GOODS /SERVICES OFFERED?	<input type="checkbox"/> Yes <input type="checkbox"/> No [IF YES ENCLOSE PROOF]		ARE YOU A FOREIGN BASED SUPPLIER FOR THE GOODS /SERVICES OFFERED?		<input type="checkbox"/> Yes <input type="checkbox"/> No [IF YES, ANSWER THE QUESTIONNAIRE BELOW]
<b>QUESTIONNAIRE TO BIDDING FOREIGN SUPPLIERS</b>					
IS THE ENTITY A RESIDENT OF THE REPUBLIC OF SOUTH AFRICA (RSA)?				<input type="checkbox"/> YES <input type="checkbox"/> NO	
DOES THE ENTITY HAVE A BRANCH IN THE RSA?				<input type="checkbox"/> YES <input type="checkbox"/> NO	
DOES THE ENTITY HAVE A PERMANENT ESTABLISHMENT IN THE RSA?				<input type="checkbox"/> YES <input type="checkbox"/> NO	
DOES THE ENTITY HAVE ANY SOURCE OF INCOME IN THE RSA?				<input type="checkbox"/> YES <input type="checkbox"/> NO	
IS THE ENTITY LIABLE IN THE RSA FOR ANY FORM OF TAXATION?				<input type="checkbox"/> YES <input type="checkbox"/> NO	
<b>IF THE ANSWER IS "NO" TO ALL OF THE ABOVE, THEN IT IS NOT A REQUIREMENT TO REGISTER FOR A TAX COMPLIANCE STATUS SYSTEM PIN CODE FROM THE SOUTH AFRICAN REVENUE SERVICE (SARS) AND IF NOT REGISTER AS PER 2.3 BELOW.</b>					

**PART B**  
**TERMS AND CONDITIONS FOR BIDDING**

<b>1. BID SUBMISSION:</b>
1.1. BIDS MUST BE DELIVERED BY THE STIPULATED TIME TO THE CORRECT ADDRESS. LATE BIDS WILL NOT BE ACCEPTED FOR CONSIDERATION.
1.2. <b>ALL BIDS MUST BE SUBMITTED ON THE OFFICIAL FORMS PROVIDED (NOT TO BE RE-TYPED) OR IN THE MANNER PRESCRIBED IN THE BID DOCUMENT.</b>
1.3. THIS BID IS SUBJECT TO THE PREFERENTIAL PROCUREMENT POLICY FRAMEWORK ACT, 2000 AND THE PREFERENTIAL PROCUREMENT REGULATIONS, THE GENERAL CONDITIONS OF CONTRACT (GCC) AND, IF APPLICABLE, ANY OTHER SPECIAL CONDITIONS OF CONTRACT.
1.4. <b>THE SUCCESSFUL BIDDER WILL BE REQUIRED TO FILL IN AND SIGN A WRITTEN CONTRACT FORM (SBD7).</b>
<b>2. TAX COMPLIANCE REQUIREMENTS</b>
2.1 BIDDERS MUST ENSURE COMPLIANCE WITH THEIR TAX OBLIGATIONS.
2.2 BIDDERS ARE REQUIRED TO SUBMIT THEIR UNIQUE PERSONAL IDENTIFICATION NUMBER (PIN) ISSUED BY SARS TO ENABLE THE ORGAN OF STATE TO VERIFY THE TAXPAYER'S PROFILE AND TAX STATUS.
2.3 APPLICATION FOR TAX COMPLIANCE STATUS (TCS) PIN MAY BE MADE VIA E-FILING THROUGH THE SARS WEBSITE <a href="http://WWW.SARS.GOV.ZA">WWW.SARS.GOV.ZA</a> .
2.4 BIDDERS MAY ALSO SUBMIT A PRINTED TCS CERTIFICATE TOGETHER WITH THE BID.
2.5 IN BIDS WHERE CONSORTIA / JOINT VENTURES / SUB-CONTRACTORS ARE INVOLVED; EACH PARTY MUST SUBMIT A SEPARATE TCS CERTIFICATE / PIN / CSD NUMBER.
2.6 WHERE NO TCS PIN IS AVAILABLE BUT THE BIDDER IS REGISTERED ON THE CENTRAL SUPPLIER DATABASE (CSD), A CSD NUMBER MUST BE PROVIDED.
2.7 NO BIDS WILL BE CONSIDERED FROM PERSONS IN THE SERVICE OF THE STATE, COMPANIES WITH DIRECTORS WHO ARE PERSONS IN THE SERVICE OF THE STATE, OR CLOSE CORPORATIONS WITH MEMBERS PERSONS IN THE SERVICE OF THE STATE."

**NB: FAILURE TO PROVIDE / OR COMPLY WITH ANY OF THE ABOVE PARTICULARS MAY RENDER THE BID INVALID.**

SIGNATURE OF BIDDER: .....

CAPACITY UNDER WHICH THIS BID IS SIGNED: .....  
(Proof of authority must be submitted e.g. company resolution)

DATE: .....

**PRICING SCHEDULE – FIRM PRICES  
 (PURCHASES)**

**NOTE: ONLY FIRM PRICES WILL BE ACCEPTED. NON-FIRM PRICES (INCLUDING PRICES SUBJECT TO RATES OF EXCHANGE VARIATIONS) WILL NOT BE CONSIDERED**

**IN CASES WHERE DIFFERENT DELIVERY POINTS INFLUENCE THE PRICING, A SEPARATE PRICING SCHEDULE MUST BE SUBMITTED FOR EACH DELIVERY POINT**

Name of bidder _____	Bid number <b>ACDP 23/05</b>
Closing Time 11:00	Closing date: <b>22 January 2024</b>

OFFER TO BE VALID FOR 120 DAYS FROM THE CLOSING DATE OF BID.

ITEM NO.	QUANTITY	DESCRIPTION	BID PRICE IN RSA CURRENCY ** (ALL APPLICABLE TAXES INCLUDED)
----------	----------	-------------	---

- 
- Required by: .....
  - At: .....
  - Brand and model .....
  - Country of origin .....
  - Does the offer comply with the specification(s)? \*YES/NO
  - If not to specification, indicate deviation(s) .....
  - Period required for delivery .....  
\*Delivery: Firm/not firm
  - Delivery basis .....

Note: All delivery costs must be included in the bid price, for delivery at the prescribed destination.

\*\* "all applicable taxes" includes value-added tax, pay as you earn, income tax, unemployment insurance fund contributions and skills development levies.

\*Delete if not applicable

\_\_\_\_\_  
 Signature of Bidder

\_\_\_\_\_  
 Date

## **BIDDER'S DISCLOSURE**

**1. PURPOSE OF THE FORM**

Any person (natural or juristic) may make an offer or offers in terms of this invitation to bid. In line with the principles of transparency, accountability, impartiality, and ethics as enshrined in the Constitution of the Republic of South Africa and further expressed in various pieces of legislation, it is required for the bidder to make this declaration in respect of the details required hereunder.

Where a person/s are listed in the Register for Tender Defaulters and / or the List of Restricted Suppliers, that person will automatically be disqualified from the bid process.

**2. Bidder's declaration**

2.1 Is the bidder, or any of its directors / trustees / shareholders / members / partners or any person having a controlling interest<sup>1</sup> in the enterprise, employed by the state? **YES/NO**

2.1.1 If so, furnish particulars of the names, individual identity numbers, and, if applicable, state employee numbers of sole proprietor/ directors / trustees / shareholders / members/ partners or any person having a controlling interest in the enterprise, in table below.

Full Name	Identity Number	Name of State institution

2.2 Do you, or any person connected with the bidder, have a relationship with any person who is employed by the procuring institution? **YES/NO**

2.2.1 If so, furnish particulars:  
 .....  
 .....

2.3 Does the bidder or any of its directors / trustees / shareholders / members / partners or any person having a controlling interest in the enterprise have any interest in any other related enterprise whether or not they are bidding for this contract? **YES/NO**

2.3.1 If so, furnish particulars:  
 .....  
 .....

---

<sup>1</sup> the power, by one person or a group of persons holding the majority of the equity of an enterprise, alternatively, the person/s having the deciding vote or power to influence or to direct the course and decisions of the enterprise.

**3 DECLARATION**

I, the undersigned, (Name).....in submitting the accompanying bid, do hereby make the following statements that I certify to be true and complete in every respect:

- 3.1 I have read and I understand the contents of this disclosure;
- 3.2 I understand that the accompanying bid will be disqualified if this disclosure is found not to be true and complete in every respect;
- 3.3 The bidder has arrived at the accompanying bid independently from, and without consultation, communication, agreement or arrangement with any competitor. However, communication between partners in a joint venture or consortium<sup>2</sup> will not be construed as collusive bidding.
- 3.4 In addition, there have been no consultations, communications, agreements or arrangements with any competitor regarding the quality, quantity, specifications, prices, including methods, factors or formulas used to calculate prices, market allocation, the intention or decision to submit or not to submit the bid, bidding with the intention not to win the bid and conditions or delivery particulars of the products or services to which this bid invitation relates.
- 3.4 The terms of the accompanying bid have not been, and will not be, disclosed by the bidder, directly or indirectly, to any competitor, prior to the date and time of the official bid opening or of the awarding of the contract.
- 3.5 There have been no consultations, communications, agreements or arrangements made by the bidder with any official of the procuring institution in relation to this procurement process prior to and during the bidding process except to provide clarification on the bid submitted where so required by the institution; and the bidder was not involved in the drafting of the specifications or terms of reference for this bid.
- 3.6 I am aware that, in addition and without prejudice to any other remedy provided to combat any restrictive practices related to bids and contracts, bids that are suspicious will be reported to the Competition Commission for investigation and possible imposition of administrative penalties in terms of section 59 of the Competition Act No 89 of 1998 and or may be reported to the National Prosecuting Authority (NPA) for criminal investigation and or may be restricted from conducting business with the public sector for a period not exceeding ten (10) years in terms of the Prevention and Combating of Corrupt Activities Act No 12 of 2004 or any other applicable legislation.

I CERTIFY THAT THE INFORMATION FURNISHED IN PARAGRAPHS 1, 2 and 3 ABOVE IS CORRECT.

I ACCEPT THAT THE STATE MAY REJECT THE BID OR ACT AGAINST ME IN TERMS OF PARAGRAPH 6 OF PFMA SCM INSTRUCTION 03 OF 2021/22 ON PREVENTING AND COMBATING ABUSE IN THE SUPPLY CHAIN MANAGEMENT SYSTEM SHOULD THIS DECLARATION PROVE TO BE FALSE.

.....  
Signature

.....  
Date

.....  
Position

.....  
Name of bidder

<sup>2</sup> Joint venture or Consortium means an association of persons for the purpose of combining their expertise, property, capital, efforts, skill and knowledge in an activity for the execution of a contract.

## PREFERENCE POINTS CLAIM FORM IN TERMS OF THE PREFERENTIAL PROCUREMENT REGULATIONS 2022

This preference form must form part of all tenders invited. It contains general information and serves as a claim form for preference points for specific goals.

**NB: BEFORE COMPLETING THIS FORM, TENDERERS MUST STUDY THE GENERAL CONDITIONS, DEFINITIONS AND DIRECTIVES APPLICABLE IN RESPECT OF THE TENDER AND PREFERENTIAL PROCUREMENT REGULATIONS, 2022**

### 1. GENERAL CONDITIONS

1.1 The following preference point systems are applicable to invitations to tender:

- the 80/20 system for requirements with a Rand value of up to R50 000 000 (all applicable taxes included); and
- the 90/10 system for requirements with a Rand value above R50 000 000 (all applicable taxes included).

### 1.2 To be completed by the organ of state

*(delete whichever is not applicable for this tender).*

- a) The applicable preference point system for this tender is the **80/20** preference point system.

1.3 Points for this tender (even in the case of a tender for income-generating contracts) shall be awarded for:

- (a) Price; and  
(b) Specific Goals.

### 1.4 To be completed by the organ of state:

The maximum points for this tender are allocated as follows:

	POINTS
PRICE	80
SPECIFIC GOALS	20
<b>Total points for Price and SPECIFIC GOALS</b>	<b>100</b>

1.5 Failure on the part of a tenderer to submit proof or documentation required in terms of this tender to claim points for specific goals with the tender, will be interpreted to mean that preference points for specific goals are not claimed.

1.6 The organ of state reserves the right to require of a tenderer, either before a tender is adjudicated or at any time subsequently, to substantiate any claim in regard to preferences, in any manner required by the organ of state.

## 2. DEFINITIONS

- (a) “**tender**” means a written offer in the form determined by an organ of state in response to an invitation to provide goods or services through price quotations, competitive tendering process or any other method envisaged in legislation;
- (b) “**price**” means an amount of money tendered for goods or services, and includes all applicable taxes less all unconditional discounts;
- (c) “**rand value**” means the total estimated value of a contract in Rand, calculated at the time of bid invitation, and includes all applicable taxes;
- (d) “**tender for income-generating contracts**” means a written offer in the form determined by an organ of state in response to an invitation for the origination of income-generating contracts through any method envisaged in legislation that will result in a legal agreement between the organ of state and a third party that produces revenue for the organ of state, and includes, but is not limited to, leasing and disposal of assets and concession contracts, excluding direct sales and disposal of assets through public auctions; and
- (e) “**the Act**” means the Preferential Procurement Policy Framework Act, 2000 (Act No. 5 of 2000).

## 3. FORMULAE FOR PROCUREMENT OF GOODS AND SERVICES

### 3.1. POINTS AWARDED FOR PRICE

#### 3.1.1 THE 80/20 OR 90/10 PREFERENCE POINT SYSTEMS

A maximum of 80 or 90 points is allocated for price on the following basis:

$$Ps = 80 \left( 1 - \frac{Pt - Pmin}{Pmin} \right) \text{ or } Ps = 90 \left( 1 - \frac{Pt - Pmin}{Pmin} \right)$$

Where

Ps = Points scored for price of tender under consideration

Pt = Price of tender under consideration

Pmin = Price of lowest acceptable tender

### 3.2. FORMULAE FOR DISPOSAL OR LEASING OF STATE ASSETS AND INCOME GENERATING PROCUREMENT

#### 3.2.1. POINTS AWARDED FOR PRICE

A maximum of 80 or 90 points is allocated for price on the following basis:

$$Ps = 80 \left( 1 + \frac{Pt - Pmax}{Pmax} \right) \text{ or } Ps = 90 \left( 1 + \frac{Pt - Pmax}{Pmax} \right)$$

Where

- Ps = Points scored for price of tender under consideration  
Pt = Price of tender under consideration  
Pmax = Price of highest acceptable tender

#### 4. POINTS AWARDED FOR SPECIFIC GOALS

- 4.1. In terms of Regulation 4(2); 5(2); 6(2) and 7(2) of the Preferential Procurement Regulations, preference points must be awarded for specific goals stated in the tender. For the purposes of this tender the tenderer will be allocated points based on the goals stated in table 1 below as may be supported by proof/ documentation stated in the conditions of this tender:
- 4.2. In cases where organs of state intend to use Regulation 3(2) of the Regulations, which states that, if it is unclear whether the 80/20 or 90/10 preference point system applies, an organ of state must, in the tender documents, stipulate in the case of—
- (a) an invitation for tender for income-generating contracts, that either the 80/20 or 90/10 preference point system will apply and that the highest acceptable tender will be used to determine the applicable preference point system; or
  - (b) any other invitation for tender, that either the 80/20 or 90/10 preference point system will apply and that the lowest acceptable tender will be used to determine the applicable preference point system,
- then the organ of state must indicate the points allocated for specific goals for both the 90/10 and 80/20 preference point system.



**Table 1: Specific goals for the tender and points claimed are indicated per the table below.**

*(Note to organs of state: Where either the 90/10 or 80/20 preference point system is applicable, corresponding points must also be indicated as such.*

*Note to tenderers: The tenderer must indicate how they claim points for each preference point system.)*

The specific goals allocated points in terms of this tender	Number of points allocated (90/10 system) (To be completed by the organ of state)	Number of points allocated (80/20 system) (To be completed by the organ of state)	Number of points claimed (90/10 system) (To be completed by the tenderer)	Number of points claimed (80/20 system) (To be completed by the tenderer)
Black People ownership > 51%		5		
Women Ownership > 51%		6		
Persons with Disability Ownership >51%		3		
Youth Ownership >51%		6		

**DECLARATION WITH REGARD TO COMPANY/FIRM**

4.3. Name of company/firm.....

4.4. Company registration number: .....

4.5. TYPE OF COMPANY/ FIRM

- Partnership/Joint Venture / Consortium
- One-person business/sole propriety
- Close corporation
- Public Company
- Personal Liability Company
- (Pty) Limited
- Non-Profit Company
- State Owned Company

[TICK APPLICABLE BOX]

4.6. I, the undersigned, who is duly authorised to do so on behalf of the company/firm, certify that the points claimed, based on the specific goals as advised in the tender, qualifies the company/ firm for the preference(s) shown and I acknowledge that:

- i) The information furnished is true and correct;
- ii) The preference points claimed are in accordance with the General Conditions as indicated in paragraph 1 of this form;
- iii) In the event of a contract being awarded as a result of points claimed as shown in paragraphs 1.4 and 4.2, the contractor may be required to furnish documentary proof to the satisfaction of the organ of state that the claims are correct;
- iv) If the specific goals have been claimed or obtained on a fraudulent basis or any of the conditions of contract have not been fulfilled, the organ of state may, in addition to any other remedy it may have –
  - (a) disqualify the person from the tendering process;
  - (b) recover costs, losses or damages it has incurred or suffered as a result of that person’s conduct;
  - (c) cancel the contract and claim any damages which it has suffered as a result of having to make less favourable arrangements due to such cancellation;
  - (d) recommend that the tenderer or contractor, its shareholders and directors, or only the shareholders and directors who acted on a fraudulent basis, be restricted from obtaining business from any organ of state for a period not exceeding 10 years, after the *audi alteram partem* (hear the other side) rule has been applied; and
  - (e) forward the matter for criminal prosecution, if deemed necessary.

..... <b>SIGNATURE(S) OF TENDERER(S)</b>	
<b>SURNAME AND NAME:</b>	.....
<b>DATE:</b>	.....
<b>ADDRESS:</b>	.....
	.....
	.....
	.....

**8 DECLARATION WITH REGARD TO COMPANY/FIRM**

8.1 Name of company/firm .....  
:

8.2 VAT registration number :.....

8.3 Company registration number  
.....  
:

**8.4 TYPE OF COMPANY/ FIRM**

- Partnership/Joint Venture / Consortium
- One person business/sole propriety
- Close corporation
- Company
- (Pty) Limited

[TICK APPLICABLE BOX]

**8.5 DESCRIBE PRINCIPAL BUSINESS ACTIVITIES**

.....  
.....  
.....

**8.6 COMPANY CLASSIFICATION**

- Manufacturer
- Supplier
- Professional service provider
- Other service providers, e.g. transporter, etc.

[TICK APPLICABLE BOX]

8.7 Total number of years the company/firm has been in business?  
.....

8.8 I/we, the undersigned, who is / are duly authorised to do so on behalf of the company/firm, certify that the points claimed, based on the B-BBE status level of contribution indicated in paragraphs 1.4 and 6.1 of the foregoing certificate, qualifies the company/ firm for the preference(s) shown and I / we acknowledge that:

- (i) The information furnished is true and correct;
- (ii) The preference points claimed are in accordance with the General

Conditions as indicated in paragraph 1 of this form.

- (iii) In the event of a contract being awarded as a result of points claimed as shown in paragraphs 1.4 and 6.1, the contractor may be required to furnish documentary proof to the satisfaction of the purchaser that the claims are correct;
- (iv) If the B-BBEE status level of contribution has been claimed or obtained on a fraudulent basis or any of the conditions of contract have not been fulfilled, the purchaser may, in addition to any other remedy it may have –
  - (a) disqualify the person from the bidding process;
  - (b) recover costs, losses or damages it has incurred or suffered as a result of that person’s conduct;
  - (c) cancel the contract and claim any damages which it has suffered as a result of having to make less favourable arrangements due to such cancellation;
  - (d) recommend that the bidder or contractor, its shareholders and directors, or only the shareholders and directors who acted on a fraudulent basis, from obtaining business from any organ of state for a period not exceeding 10 years, after the *audi alteram partem* (hear the other side) rule has been applied; and
  - (e) forward the matter for criminal prosecution

.....  
**SIGNATURE(S) OF BIDDER(S)**

**WITNESSES:**

1. ....

2. ....

DATE:.....

ADDRESS:.....

.....





[Add more pages as required]

**U. CONTRACTOR'S HEALTH AND SAFETY DECLARATION**

In terms of Clause 4(4) of the OHS Act 1993 Construction Regulations 2003 (referred to as "the Regulations" hereafter), a Contractor may only be appointed to perform construction Work if the Employer is satisfied that the Contractor has the necessary competencies and resources to carry out the Work safely in accordance with the Occupational Health and Safety Act No 85 of 1993 and the OHS Act 1993 Construction Regulations 2003.

To that effect a person duly authorised by the Tenderer must complete and sign the declaration hereafter in detail.

**Declaration by Tenderer**

1. I the undersigned hereby declare and confirm that I am fully conversant with the Occupational Health and Safety Act No 85 of 1993 (as amended by the Occupational Health and Safety Amendment Act No 181 of 1993), and the OHS Act 1993 Construction Regulations 2003.
2. I hereby declare that my Company has the competence and the necessary resources to safely carry out the construction Work under this Contract in compliance with the Construction Regulations and the Employer's Health and Safety Specifications.
3. I propose to achieve compliance with the Regulations by one of the following:
  - (a) From my own competent resources as detailed in 4(a) hereafter: ..... **\*Yes / No**
  - (b) From my own resources still to be appointed or trained until competency is achieved, as detailed in 4(b) hereafter: ..... **\*Yes / No**
  - (c) From outside sources by appointment of competent specialist Subcontractors as detailed in 4(c) hereafter: ..... **\*Yes / No**

(\* = delete whatever is not applicable)

4. Details of resources I propose:

*(Note: Competent resources shall include safety personnel such as a construction supervisor and Construction Safety Officer as defined in Regulation 6, and Competent Persons as defined in Regulations 7, 8, 10, 11, 12, 14, 15, 18, 21(1), 22, 26 and 27, as applicable to this Contract)*

- (a) Details of the competent and qualified key persons from my Company's own resources, who will form part of the Contract team:

NAMES OF COMPETENT PERSONS	POSITIONS TO BE FILLED BY COMPETENT PERSONS

(b) Details of training of persons from my Company's own resources (or to be hired) who still have to be trained to achieve the necessary competency:

(i) By whom will training be provided? .....

(ii) When will training be undertaken? .....

(iii) List the positions to be filled by persons to be trained or hired: .....

.....  
.....  
.....

(c) Details of competent resources to be appointed as Subcontractors if Competent Persons cannot be supplied from own Company:

Name of proposed Subcontractor: .....

Qualifications or details of competency of the Subcontractor: .....

.....  
.....  
.....

5. I hereby undertake, if my Tender is accepted, to provide, before commencement of the Works under the Contract, a suitable and sufficiently Documented Health and Safety Plan in accordance with Regulation 5(1) of the Construction Regulations, which plan shall be subject to approval by the Employer.

6. I confirm that copies of my Company's approved Health and Safety Plan, the Employer's Safety Specifications as well as the OHSA 1993 Construction Regulations 2003 will be provided on Site and will at all times be available for inspection by the Contractor's personnel, the Employer's personnel, the Engineer, visitors, and Officials and Inspectors of the Department of Labour.

7. I hereby confirm that adequate provision has been made in my Tendered rates and prices in the Schedule of Quantities to cover the cost of all resources, actions, training and all health and safety measures envisaged in the OHSA 1993 Construction Regulations 2003, and that I will be liable for any penalties that may be applied by the Employer in terms of the said Regulations (Regulation 30) for failure on the Contractor's part to comply with the Provisions of the Act and the Regulations.

8. I agree that my failure to complete and execute this declaration to the satisfaction of the Employer will mean that I am unable to comply with the requirements of the OHSA 1993 Construction Regulations 2003, and accept that my Tender will be prejudiced and may be rejected at the discretion of the Employer.

SIGNATURE: .....  
(of person authorised to sign on behalf of the Tenderer)

DATE: .....



---

## V. CONTRACTOR'S SAFETY PLAN

***[The Contractor shall submit the Contractor's Health and Safety Plan as required in terms of Regulation 5 of the Occupational Health and Safety Act 1993 Construction Regulations 2003, and referred to in T2.1, before commencement of the Works.]***

**W. PRO FORMA NOTIFICATION FORM IN TERMS OF THE OCCUPATIONAL HEALTH AND SAFETY ACT 1993, CONSTRUCTION REGULATIONS 2003**

***[This form must be completed and forwarded, prior to commencement of Work on Site, by all Contractors that qualify in terms of Regulation 3 of the Construction Regulations 2003, to the Office of the Department of Labour]***

1. (a) Name and postal address of Contractor:.....  
.....
- (b) Name of Contractor's contact person: .....  
Telephone number: .....
2. Contractor's Workman's compensation registration number: .....
3. (a) Name and postal address of Client: .....  
.....
- (b) Name of Client's contact person or Agent: .....  
Telephone number.....
4. (a) Name and postal address of designer(s) for the Project: .....  
.....
- (b) Name of Designer's contact person: .....  
Telephone number.....
5. Name of Contractor's Construction Supervisor on Site appointed in terms of Regulation 6(1): ..... Telephone number: .....
6. Name/s of Contractor's sub-ordinate supervisors on Site appointed in terms of Regulation 6(2).  
.....
7. Exact physical address of the construction Site or Site Office: .....
8. Nature of the construction Work: .....
9. Expected Commencement Date: .....
10. Expected Completion Date: .....
11. Estimated maximum number of persons on the construction Site: .....
12. Planned number of Subcontractors on the construction Site accountable to Contractor: .....
13. Name(s) of Subcontractors already chosen: .....
- .....
- .....
- .....

SIGNED BY:

CONTRACTOR: ..... DATE: .....

CLIENT: ..... DATE: .....

## X. MONTHLY LABOUR REPORT

**MONTHLY LABOUR REPORT FOR CERTIFICATE OF PAYMENT NO. ....**

**JOBS CREATED.....**

### AS PER BUSINESS PLAN

A	B	C	D	E	F	G	H	I	J
Category	Number of persons employed in category	Rate (R/d)	Local P-days	Non-local P-Days	Total P-days (D+E)	Amount expended on labour (C x F)	P-days by women	P-days by youth	P-days by disabled
Clerical									
Managerial									
Supervisory									
Skilled									
Semi-skilled									
Unskilled									
All operations									

### ACTUAL TO DATE

A	B	C	D	E	F	G	H	I	J
Category	Number of persons employed in category	Rate (R/d)	Local P-days	Non-local P-Days	Total P-days (D+E)	Amount expended on labour (C x F)	P-days by women	P-days by youth	P-days by disabled
Clerical									
Managerial									
Supervisory									
Skilled									
Semi-skilled									
Unskilled									
All operations									

### SUMMARY

Planned person-days target  
 Tendered construction period (months):  
 Overall person-days target per month:  
 Months represented by this report:  
 Person-day target for this month:  
 Achieved person-days to date:  
 Person-days ahead/behind target:

**ANNEXURE A: BIDDER'S DETAILED EXPERIENCE – REFERENCE SHEET**

The following are to be completed by the Client and Principal Agent/ Consultant and is to be supported in each case by a letter of award and the works completion certificate. Both client and Pricipal Agent must stamp the documents, failure to obtain both stamp will result in no allocation of points.

**Project Name and scope of work:**

**Scope of work :**

.....

**Contract duration:**

.....

**Actual Contract Duration:**

.....

Name of Institution/company /place where contract was undertaken/ Client	Principal Agent/ Consultant	Value of contract	Contract Duration (in days, weeks, months, years)	Actual Contract Duration (in days, weeks, months, years)

**To be filled by Principal Agent**

Description/Perfomance	Very Poor (1)	Poor (2)	Fair (3)	Good (4)	Excellent (5)
Quality of office administration					
Quality of Site Management					
Competence Foreman					
Co-operation during contract					
Quality of workmanship					
Quality of materials					
Programme management					
Rectification of condemned work					
Tidiness of site					
Adequacy of equipment					
Adequacy of labour force					
Procurement of material					
Labour relations					

**Any other additional remarks considered necessary to assist in evaluation of the contractor?**

.....  
 .....

Principal Agent/consultant Firm.....

Telephone .....

Principal Agent/consultant Signature .....

Date .....

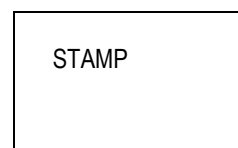

**ANNEXURE A: BIDDER'S DETAILED EXPERIENCE – REFERENCE SHEET**

The following are to be completed by the Client and Principal Agent/ Consultant and is to be supported in each case by a letter of award and the works completion certificate. Both client and Pricipal Agent must stamp the documents, failure to obtain both stamp will result in no allocation of points.

**Project Name and scope of work:**

**Scope of work :**

.....

**Contract duration:**

.....

**Actual Contract Duration:**

.....

Name of Institution/company /place where contract was undertaken/ Client	Principal Agent/ Consultant	Value of contract	Contract Duration (in days, weeks, months, years)	Actual Contract Duration (in days, weeks, months, years)

**To be filled by Principal Agent**

Description/Perfomance	Very Poor (1)	Poor (2)	Fair (3)	Good (4)	Excellent (5)
Quality of office administration					
Quality of Site Management					
Competence Foreman					
Co-operation during contract					
Quality of workmanship					
Quality of materials					
Programme management					
Rectification of condemned work					
Tidiness of site					
Adequacy of equipment					
Adequacy of labour force					
Procurement of material					
Labour relations					

**Any other additional remarks considered necessary to assist in evaluation of the contractor?**

.....

.....

Principal Agent/consultant Firm.....

Telephone .....

Principal Agent/consultant Signature .....

Date .....

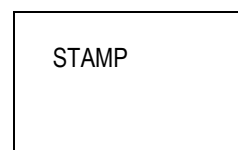

**ANNEXURE A: BIDDER'S DETAILED EXPERIENCE – REFERENCE SHEET**

The following are to be completed by the Client and Principal Agent/ Consultant and is to be supported in each case by a letter of award and the works completion certificate. Both client and Pricipal Agent must stamp the documents, failure to obtain both stamp will result in no allocation of points.

**Project Name and scope of work:**

**Scope of work :**

.....

**Contract duration:**

.....

**Actual Contract Duration:**

.....

Name of Institution/company /place where contract was undertaken/ Client	Principal Agent/ Consultant	Value of contract	Contract Duration (in days, weeks, months, years)	Actual Contract Duration (in days, weeks, months, years)

**To be filled by Principal Agent**

Description/Perfomance	Very Poor (1)	Poor (2)	Fair (3)	Good (4)	Excellent (5)
Quality of office administration					
Quality of Site Management					
Competence Foreman					
Co-operation during contract					
Quality of workmanship					
Quality of materials					
Programme management					
Rectification of condemned work					
Tidiness of site					
Adequacy of equipment					
Adequacy of labour force					
Procurement of material					
Labour relations					

**Any other additional remarks considered necessary to assist in evaluation of the contractor?**

.....  
 .....

Principal Agent/consultant Firm.....

Telephone .....

Principal Agent/consultant Signature .....

Date .....

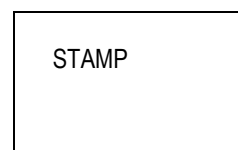

**ANNEXURE A: BIDDER'S DETAILED EXPERIENCE – REFERENCE SHEET**

The following are to be completed by the Client and Principal Agent/ Consultant and is to be supported in each case by a letter of award and the works completion certificate. Both client and Pricipal Agent must stamp the documents, failure to obtain both stamp will result in no allocation of points.

**Project Name and scope of work:**

**Scope of work :**

.....

**Contract duration:**

.....

**Actual Contract Duration:**

.....

Name of Institution/company /place where contract was undertaken/ Client	Principal Agent/ Consultant	Value of contract	Contract Duration (in days, weeks, months, years)	Actual Contract Duration (in days, weeks, months, years)

**To be filled by Principal Agent**

Description/Perfomance	Very Poor (1)	Poor (2)	Fair (3)	Good (4)	Excellent (5)
Quality of office administration					
Quality of Site Management					
Competence Foreman					
Co-operation during contract					
Quality of workmanship					
Quality of materials					
Programme management					
Rectification of condemned work					
Tidiness of site					
Adequacy of equipment					
Adequacy of labour force					
Procurement of material					
Labour relations					

**Any other additional remarks considered necessary to assist in evaluation of the contractor?**

.....  
 .....

Principal Agent/consultant Firm.....

Telephone .....

Principal Agent/consultant Signature .....

Date .....

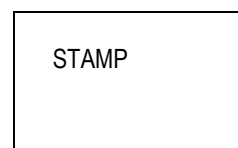

**ANNEXURE A: BIDDER'S DETAILED EXPERIENCE – REFERENCE SHEET**

The following are to be completed by the Client and Principal Agent/ Consultant and is to be supported in each case by a letter of award and the works completion certificate. Both client and Pricipal Agent must stamp the documents, failure to obtain both stamp will result in no allocation of points.

**Project Name and scope of work:**

**Scope of work :**

.....

**Contract duration:**

.....

**Actual Contract Duration:**

.....

Name of Institution/company /place where contract was undertaken/ Client	Principal Agent/ Consultant	Value of contract	Contract Duration (in days, weeks, months, years)	Actual Contract Duration (in days, weeks, months, years)

**To be filled by Principal Agent**

Description/Perfomance	Very Poor (1)	Poor (2)	Fair (3)	Good (4)	Excellent (5)
Quality of office administration					
Quality of Site Management					
Competence Foreman					
Co-operation during contract					
Quality of workmanship					
Quality of materials					
Programme management					
Rectification of condemned work					
Tidiness of site					
Adequacy of equipment					
Adequacy of labour force					
Procurement of material					
Labour relations					

**Any other additional remarks considered necessary to assist in evaluation of the contractor?**

.....  
 .....

Principal Agent/consultant Firm.....

Telephone .....

Principal Agent/consultant Signature .....

Date .....

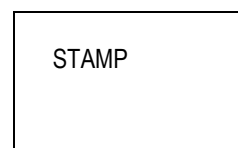



**ANNEXURE A: BIDDER'S DETAILED EXPERIENCE – REFERENCE SHEET**

The following are to be completed by the Client and Principal Agent/ Consultant and is to be supported in each case by a letter of award and the works completion certificate. Both client and Pricipal Agent must stamp the documents, failure to obtain both stamp will result in no allocation of points.

**Project Name and scope of work:**

**Scope of work :**

.....

**Contract duration:**

.....

**Actual Contract Duration:**

.....

Name of Institution/company /place where contract was undertaken/ Client	Principal Agent/ Consultant	Value of contract	Contract Duration (in days, weeks, months, years)	Actual Contract Duration (in days, weeks, months, years)

**To be filled by Principal Agent**

Description/Perfomance	Very Poor (1)	Poor (2)	Fair (3)	Good (4)	Excellent (5)
Quality of office administration					
Quality of Site Management					
Competence Foreman					
Co-operation during contract					
Quality of workmanship					
Quality of materials					
Programme management					
Rectification of condemned work					
Tidiness of site					
Adequacy of equipment					
Adequacy of labour force					
Procurement of material					
Labour relations					

**Any other additional remarks considered necessary to assist in evaluation of the contractor?**

.....  
 .....

Principal Agent/consultant Firm.....

Telephone .....

Principal Agent/consultant Signature .....

Date .....

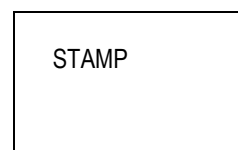

**ANNEXURE A: BIDDER'S DETAILED EXPERIENCE – REFERENCE SHEET**

The following are to be completed by the Client and Principal Agent/ Consultant and is to be supported in each case by a letter of award and the works completion certificate. Both client and Pricipal Agent must stamp the documents, failure to obtain both stamp will result in no allocation of points.

**Project Name and scope of work:**

**Scope of work :**

.....

**Contract duration:**

.....

**Actual Contract Duration:**

.....

Name of Institution/company /place where contract was undertaken/ Client	Principal Agent/ Consultant	Value of contract	Contract Duration (in days, weeks, months, years)	Actual Contract Duration (in days, weeks, months, years)

**To be filled by Principal Agent**

Description/Perfomance	Very Poor (1)	Poor (2)	Fair (3)	Good (4)	Excellent (5)
Quality of office administration					
Quality of Site Management					
Competence Foreman					
Co-operation during contract					
Quality of workmanship					
Quality of materials					
Programme management					
Rectification of condemned work					
Tidiness of site					
Adequacy of equipment					
Adequacy of labour force					
Procurement of material					
Labour relations					

**Any other additional remarks considered necessary to assist in evaluation of the contractor?**

.....  
 .....

Principal Agent/consultant Firm.....

Telephone .....

Principal Agent/consultant Signature .....

Date .....

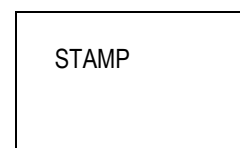

**ANNEXURE A: BIDDER'S DETAILED EXPERIENCE – REFERENCE SHEET**

The following are to be completed by the Client and Principal Agent/ Consultant and is to be supported in each case by a letter of award and the works completion certificate. Both client and Pricipal Agent must stamp the documents, failure to obtain both stamp will result in no allocation of points.

**Project Name and scope of work:**

**Scope of work :**

.....

**Contract duration:**

.....

**Actual Contract Duration:**

.....

Name of Institution/company /place where contract was undertaken/ Client	Principal Agent/ Consultant	Value of contract	Contract Duration (in days, weeks, months, years)	Actual Contract Duration (in days, weeks, months, years)

**To be filled by Principal Agent**

Description/Perfomance	Very Poor (1)	Poor (2)	Fair (3)	Good (4)	Excellent (5)
Quality of office administration					
Quality of Site Management					
Competence Foreman					
Co-operation during contract					
Quality of workmanship					
Quality of materials					
Programme management					
Rectification of condemned work					
Tidiness of site					
Adequacy of equipment					
Adequacy of labour force					
Procurement of material					
Labour relations					

**Any other additional remarks considered necessary to assist in evaluation of the contractor?**

.....  
 .....

Principal Agent/consultant Firm.....

Telephone .....

Principal Agent/consultant Signature .....

Date .....

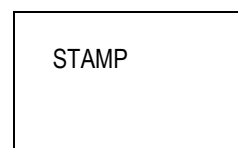

**ANNEXURE A: BIDDER'S DETAILED EXPERIENCE – REFERENCE SHEET**

The following are to be completed by the Client and Principal Agent/ Consultant and is to be supported in each case by a letter of award and the works completion certificate. Both client and Pricipal Agent must stamp the documents, failure to obtain both stamp will result in no allocation of points.

**Project Name and scope of work:**

**Scope of work :**

.....

**Contract duration:**

.....

**Actual Contract Duration:**

.....

Name of Institution/company /place where contract was undertaken/ Client	Principal Agent/ Consultant	Value of contract	Contract Duration (in days, weeks, months, years)	Actual Contract Duration (in days, weeks, months, years)

**To be filled by Principal Agent**

Description/Perfomance	Very Poor (1)	Poor (2)	Fair (3)	Good (4)	Excellent (5)
Quality of office administration					
Quality of Site Management					
Competence Foreman					
Co-operation during contract					
Quality of workmanship					
Quality of materials					
Programme management					
Rectification of condemned work					
Tidiness of site					
Adequacy of equipment					
Adequacy of labour force					
Procurement of material					
Labour relations					

**Any other additional remarks considered necessary to assist in evaluation of the contractor?**

.....  
 .....

Principal Agent/consultant Firm.....

Telephone .....

Principal Agent/consultant Signature .....

Date .....

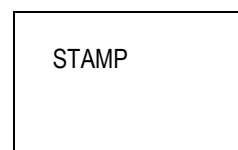

**ANNEXURE A: BIDDER'S DETAILED EXPERIENCE – REFERENCE SHEET**

The following are to be completed by the Client and Principal Agent/ Consultant and is to be supported in each case by a letter of award and the works completion certificate. Both client and Pricipal Agent must stamp the documents, failure to obtain both stamp will result in no allocation of points.

**Project Name and scope of work:**

**Scope of work :**

.....

**Contract duration:**

.....

**Actual Contract Duration:**

.....

Name of Institution/company /place where contract was undertaken/ Client	Principal Agent/ Consultant	Value of contract	Contract Duration (in days, weeks, months, years)	Actual Contract Duration (in days, weeks, months, years)

**To be filled by Principal Agent**

Description/Perfomance	Very Poor (1)	Poor (2)	Fair (3)	Good (4)	Excellent (5)
Quality of office administration					
Quality of Site Management					
Competence Foreman					
Co-operation during contract					
Quality of workmanship					
Quality of materials					
Programme management					
Rectification of condemned work					
Tidiness of site					
Adequacy of equipment					
Adequacy of labour force					
Procurement of material					
Labour relations					

**Any other additional remarks considered necessary to assist in evaluation of the contractor?**

.....  
 .....

Principal Agent/consultant Firm.....

Telephone .....

Principal Agent/consultant Signature .....

Date .....

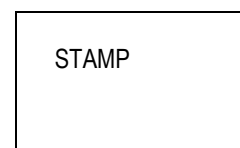

## **THE CONTRACT**

**PART C1: AGREEMENTS AND CONTRACT DATA**

**PART C2: PRICING DATA**

**PART C3: SCOPE OF WORK**

**PART C4: SITE INFORMATION**

## **LIMPOPO DEPARTMENT OF AGRICULTURE AND RURAL DEVELOPMENT**

### **CONSTRUCTION OF CHILI PEPPER DRYING FACILITY AT ROYAL FIELDS FARM UNDER MUSINA LOCAL MUNICIPALITY IN VHEMBE DISTRICT OF LIMPOPO PROVINCE**

#### **TABLE OF CONTENTS**

##### **PART C1: AGREEMENTS AND CONTRACT DATA (YELLOW COLOUR)**

**C1.1: FORM OF OFFER AND ACCEPTANCE**

**C1.2: CONTRACT DATA**

**C1.2.1: CONDITIONS OF CONTRACT**

**C1.2.2: PART A: CONTRACT DATA PROVIDED BY THE EMPLOYER**

**PART B: CONTRACT DATA PROVIDED BY THE CONTRACTOR**

**C1.3: FORM OF GUARANTEE**

**C1.4: AGREEMENT IN TERMS OF SECTION 37(2) OF THE  
OCCUPATIONAL HEALTH AND SAFETY ACT No 85 OF 1993**

##### **PART C2: PRICING DATA (YELLOW COLOUR)**

**C2.1: PRICING INSTRUCTIONS**

**C2.2: BILL OF QUANTITIES**

**C2.3: PAYMENT DATA**

##### **PART C3: SCOPE OF WORK (BLUE COLOUR)**

**TABLE OF CONTENTS**

**C3.1: STANDARD SPECIFICATIONS**

**C3.2: PROJECT SPECIFICATIONS**

**C3.3: PARTICULAR SPECIFICATIONS**

## **PART C1: AGREEMENTS AND CONTRACT DATA**

### **C1.1: FORM OF OFFER AND ACCEPTANCE**

### **C1.2: CONTRACT DATA**

C1.2.1: CONDITIONS OF CONTRACT

C1.2.2: PART A: CONTRACT DATA PROVIDED BY THE EMPLOYER

PART B: CONTRACT DATA PROVIDED BY THE CONTRACTOR

### **C1.3: FORM OF GUARANTEE (NOT A REQUIREMENT)**

### **C1.4: AGREEMENT IN TERMS OF SECTION 37(2) OF THE OCCUPATIONAL HEALTH AND SAFETY ACT (No 85 OF 1993)**



**LIMPOPO DEPARTMENT OF AGRICULTURE AND RURAL DEVELOPMENT**

**CONSTRUCTION OF CHILI PEPPER DRYING FACILITY AT ROYAL FIELDS FARM UNDER MUSINA LOCAL MUNICIPALITY IN VHEMBE DISTRICT OF LIMPOPO PROVINCE**

**C1.1 Form of Offer and Acceptance**

**Offer**

The Employer, identified in the Acceptance Signature block, has solicited Offers to enter into a Contract for the procurement of:

**CONTRACT NO ACDP 23/05: CONSTRUCTION OF CHILI PEPPER DRYING FACILITY AT ROYAL FIELDS FARM UNDER MUSINA LOCAL MUNICIPALITY IN VHEMBE DISTRICT OF LIMPOPO PROVINCE**

The Tenderer, identified in the Offer Signature block, has examined the Documents listed in the Tender Data and addenda thereto as listed in the Returnable Schedules, and by submitting this Offer has accepted the Conditions of Tender.

By the representative of the Tenderer, deemed to be duly authorized, signing this part of this Form of Offer and Acceptance, the Tenderer Offers to perform all of the obligations and liabilities of the Contractor under the Contract including compliance with all its Terms and Conditions according to their true intent and meaning for an amount to be determined in accordance with the Conditions of Contract identified in the Contract Data.

**THE OFFERED TOTAL OF THE PRICES INCLUSIVE OF VALUE ADDED TAX IS:**

.....  
 ..... Rand (in words);  
**R** ..... (in figures)

This Offer may be accepted by the Employer by signing the Acceptance part of this Form of Offer and Acceptance and returning one copy of this Document to the Tenderer before the end of the period of validity stated in the Tender Data, whereupon the Tenderer becomes the Party named as the Contractor in the Conditions of Contract identified in the Contract Data.

Signature Block: Tenderer	
Signature .....	Date .....
Name .....	
Capacity .....	
Name of organization .....	
Address of organization .....	
.....	
Signature of witness .....	Date .....
Name of witness .....	

## Acceptance

By signing this part of this Form of Offer and Acceptance, the Employer identified below accepts the Tenderer's Offer. In consideration thereof, the Employer shall pay the Contractor the amount due in accordance with the conditions of Contract identified in the Contract Data. Acceptance of the Tenderer's Offer shall Form an Agreement between the Employer and the Tenderer upon the Terms and Conditions contained in this Agreement and in the Contract that is the subject of this Agreement.

The terms of the Contract, are contained in:

- Part C1: Agreements and Contract Data, (which includes this Agreement)
- Part C2: Pricing Data
- Part C3: Scope of work.
- Part C4: Site Information and Drawings and Documents or parts thereof, which may be incorporated by reference into Parts C1 to C4 above.

Deviations from and amendments to the Documents listed in the Tender Data and any addenda thereto as listed in the Tender Schedules as well as any changes to the Terms of the Offer agreed by the Tenderer and the Employer during this process of Offer and Acceptance, are contained in the Schedule of Deviations attached to and Forming part of this Agreement. No amendments to or deviations from said Documents are valid unless contained in this schedule.

The Tenderer shall within two weeks after receiving a completed copy of this Agreement, including the Schedule of Deviations (if any), contact the Employer's agent (whose details are given in the Contract Data) for delivery of any Bonds, Guarantees, proof of Insurance and any other Documentation to be provided in terms of the Conditions of Contract Identified in the Contract Data. Failure to fulfil any of these Obligations in accordance with those terms shall constitute a repudiation of this Agreement.

Notwithstanding anything contained herein, this Agreement comes into effect on the date when the Tenderer receives one fully completed original copy of this Document, including the Schedule of Deviations (if any). Unless the Tenderer (now Contractor) within five working days of the date of such receipt notifies the Employer in writing of any reason why he cannot accept the Contents of this Agreement, this Agreement shall constitute a binding Contract between the Parties.

<b>Signature Block: Employer</b>	
Signature .....	Date .....
Name .....	
Capacity .....	
<b>for the Employer</b>	Limpopo Department of Agriculture and Rural Development
Signature of witness .....	Date .....
Name of witness .....	

## Schedule of Deviations

- 1 Subject .....
- Details .....
- .....
- .....
- .....
- .....
- 2 Subject .....
- Details .....
- .....
- .....
- .....
- .....
- 3 Subject .....
- Details .....
- .....
- .....
- .....
- .....
- 4 Subject .....
- Details .....
- .....
- .....
- .....
- .....
- 5 Subject .....
- Details .....
- .....
- .....
- .....
- .....

By the duly Authorised Representatives signing this Agreement, the Employer and the Tenderer agree to and accept the foregoing Schedule of Deviations as the only deviations from and amendments to the Documents listed in the Tender Data and addenda thereto as listed in the Tender Schedules, as well as any confirmation, clarification or changes to the terms of the Offer agreed by the Tenderer and the Employer during this process of Offer and Acceptance.

It is expressly agreed that no other matter whether in writing, oral communication or implied during the period between the issue of the Tender Documents and the receipt by the Tenderer of a completed signed copy of this Agreement shall have any meaning or effect in the Contract between the parties arising from this Agreement.

*[ONLY TO BE COMPLETED UPON ACCEPTANCE OF A TENDER]*

For the Tenderer:

Signature(s) \_\_\_\_\_

Name(s) \_\_\_\_\_

Capacity \_\_\_\_\_

\_\_\_\_\_  
(Name and address of organisation)

Name & Signature of Witness \_\_\_\_\_ Date \_\_\_\_\_

For the Employer:

Signature(s) \_\_\_\_\_

Name(s) \_\_\_\_\_

Capacity \_\_\_\_\_

\_\_\_\_\_  
(Name and address of organisation)

---

## LIMPOPO DEPARTMENT OF AGRICULTURE AND RURAL DEVELOPMENT

### CONSTRUCTION OF CHILI PEPPER DRYING FACILITY AT ROYAL FIELDS FARM UNDER MUSINA LOCAL MUNICIPALITY IN VHEMBE DISTRICT OF LIMPOPO PROVINCE

#### C1.2 CONTRACT DATA

*Section 1.01 The General Conditions of Contract for Construction Works (2010) published by the South African Institution of Civil Engineering, is applicable to this Contract. Copies of these Conditions of Contract may be obtained from the South African Institution of Civil Engineering (Tel: 011-805 5947).*

The General Conditions of Contract for Construction Works make several references to the Contract Data for Specific Data, which together with these Conditions collectively describe the risks, liabilities and obligations of the Contracting parties and the procedures for the administration of the Contract. The Contract Data shall have precedence in the interpretation of any ambiguity or inconsistency between it and the General Conditions of Contract.

Each item of Data given below is cross-referenced to the clause in the General Conditions of Contract for Construction Works to which it mainly applies.

---

## **LIMPOPO DEPARTMENT OF AGRICULTURE AND RURAL DEVELOPMENT**

### **CONSTRUCTION OF CHILI PEPPER DRYING FACILITY AT ROYAL FIELDS FARM UNDER MUSINA LOCAL MUNICIPALITY IN VHEMBE DISTRICT OF LIMPOPO PROVINCE**

#### **C1.2.1: CONDITIONS OF CONTRACT**

##### **GENERAL CONDITIONS OF CONTRACT**

##### **SPECIAL CONDITIONS OF CONTRACT**

- 1. GENERAL**
- 2. AMENDMENTS TO THE GENERAL CONDITIONS OF CONTRACT**
- 3. TRANSFER OF RIGHTS**

## C1.2.1 CONDITIONS OF CONTRACT

### GENERAL CONDITIONS OF CONTRACT

This Contract will be based on the "General Conditions of Contract for Construction Works - 1st Edition 2010", issued by the South African Institution of Civil Engineering (Short title: "**General Conditions of Contract 2010**") and can be obtained from:

#### SAICE

Waterfall Park  
Howick Gardens  
Vorna Valley Half way House  
Becker Street  
MIDRAND  
1685  
Gauteng Province  
Tel: (011) 805-5947/8  
Fax: (011) 805-5971

It is agreed that the only variations from the General Conditions of Contract 2010 are those set out hereafter under "Special Conditions of Contract".

### SPECIAL CONDITIONS OF CONTRACT

#### 1. GENERAL

These Special Conditions of Contract (SCC) form an integral part of the Contract. The Special Conditions shall amplify, modify or supersede, as the case may be, the General Conditions of Contract 2010 to the extent specified below, and shall take precedence and shall govern.

The clauses of the Special Conditions hereafter are numbered "SCC" followed in each case by the number of the applicable clause or sub clause in the General Conditions of Conditions 2010, and the applicable heading, or (where a new special condition that has no relation to the existing clauses is introduced) by a number that follows after the last clause number in the General Conditions, and an appropriate heading.

#### 2. FOR CONTRACT ABOVE R3M (THREE MILLION RAND), THE FOLLOWING SPECIAL CONDITIONS APPLY

- (a) (i) All bidders from outside the province must enter into a Consortium or Joint Venture with local SMMEs or suppliers.
  - (ii) Preference must be given to local bidders entering into Joint Ventures with local SMME's or suppliers.
  - (iii) The members of consortium or Joint Venture, formed in response to preferential procurement conditions, must share in the control and management of such consortium.
  - (iv) The percentage of the contract value managed or executed by the local partner must not be less than 40% of the project value.
  - (v) All white owned bidders must enter into join venture with black owned local contractor and percentage of management and control for equity owned by black must not be less than 25% in the venture arrangement.
- (b) The AO/AA may, after consulting the departmental or public entities demand management unit, in the bid documentation, exempt bidders from complying with the provisions of clause (a), if there are no SMME's or suppliers in Limpopo with the skills or knowledge required to execute the project.
- (c) In the case of construction works, applicable to the construction industry;
- (d) (i) The Consortium or Joint Venture that benefits from the preference system, must within 30 days of receiving notice of the contract ,must organize themselves into legal entity or provide with a working agreement between members of the Joint venture or consortium. Successful suppliers, both from in and outside the province, must upon implementation of the project, establish fully fledged office, branch or plant in the province.

- The department reserves the right to retain a percentage of contract value to ensure that the above condition is complied with.
- (ii) The retained fee must be paid to the supplier or service provider on successfully completing the contract and after having complied with the special conditions.
  - (iii) Where the supplier or service provider fails to successfully complete the contract or comply with any condition, such supplier or service provider will forfeit the retained percentage.
  - (iv) Notwithstanding the forfeiture of the retained percentage of the contract value, if the failure to comply with conditions in clause (i) amounts to breach of the contract, the department or public entity may invoke any remedy available to it in law.
  - (v) A performance guarantee of 10% is applicable to all contracts above R2 000 000.00 and must be obtained from either commercial bank or insurance company prior to award of bids. The performance security shall be dominated in the currency of the contract and shall be in the form of a bank guarantee or an irrevocable letter of credit issued by a reputable bank located in South Africa. The accounting officer reserves the right to cancel the award of the bid when the bidder fails to present the required security as stipulated in the special conditions.
- (e) In all labour intensive projects, at least 70% of the labourers must be employed from the local community where the project will be executed.

### 3. AMENDMENTS TO THE GENERAL CONDITIONS OF CONTRACT

Clause no.	Description
<b>SCC 4.5.2</b>	Replace the term “Safety” with “Occupational Health and Safety”
<b>SCC 42.2</b>	Add the following to the sub-clause: Extension of time in respect of abnormal rainfall shall be calculated using the rainfall (Formula 1) for each calendar month or part thereof.
<b>SCC 49.6.1 to 4.9.6.3</b>	Replace the term “Bank” with “Bank or Insurance Company”
<b>SCC 55.1.8</b>	Replace sub-clause with: The Contractor or anyone on his behalf or in his employ would pay, offer or offer as payment to any person in the employ of the Employer, or in the employ of the Engineer, a gratuity or reward or commission.
<b>SCC 50</b>	Replace the Heading with “ <b>VARIATIONS EXCEEDING 20 PERCENT</b> ”
<b>SCC 50.1</b>	Replace the wording: “ <i>greater than 15 percent</i> ” with “ <i>greater than 20 percent</i> ”.
	<b><u>The following additional clauses to the General Conditions of Contract shall apply:</u></b>



<b>SCC 59</b>	<b>LABOUR INTENSIVE WORKS</b>
<b>SCC 59.1</b>	<p><b>Payment for the labour-intensive component of the works</b></p> <p>Payment for works identified in the Scope of Work as being labour-intensive shall only be made in accordance with the provisions of the Contract if the works are constructed strictly in accordance with the provisions of the scope of work. Any non-payment for such works shall not relieve the Contractor in any way from his obligations either in Contract or in delict.</p>
<b>SCC 59.2</b>	<p><b>Applicable labour laws</b></p> <p>The Ministerial Determination, Special Public Works Programmes, issued in terms of the Basic Conditions of Employment Act of 1997 by the Minister of Labour in Government Notice No R63 of 25 January 2002, as reproduced below, shall apply to work which are undertaken by unskilled or semi-skilled workers.</p>
<b>SCC 59.3.1</b>	<p><b>Introduction</b></p> <p>(a) This document contains the Standard Terms and Conditions for workers employed in elementary occupations on a Special Public Works Programme (SPWP). These terms and Conditions do NOT apply to persons employed in the supervision and management of a SPWP.</p> <p>(b) In this document –</p> <ul style="list-style-type: none"> <li>(i) “Department” means any department of State, implementing Agent or Contractor;</li> <li>(ii) “Employer” means any Municipality, implementing Agency or Contractor that hires workers to work in elementary occupations on a SPWP;</li> <li>(iii) “worker” means any person working in an elementary occupation on a SPWP.;</li> <li>(iv) “elementary occupation” means any occupation involving unskilled or semi-skilled work;</li> <li>(v) “Management” means any person employed by a Municipality or implementing Agency to administer or execute an SPWP;</li> <li>(vi) “task” means a fixed quantity of work;</li> <li>(vii) “task-based work” means work in which a worker is paid a fixed rate for performing a task;</li> <li>(viii) “task-rated worker” means a worker paid on the basis of the number of tasks completed;</li> <li>(ix) “time-rated worker” means a worker paid on the basis of the length of time worked.</li> </ul>
<b>SCC 59.3.2</b>	<p><b>Terms of Work</b></p> <ul style="list-style-type: none"> <li>(a) Workers on a SPWP are employed on a temporary basis.</li> <li>(b) A worker may NOT be employed for longer than 24 months in any five year cycle on a SPWP.</li> <li>(c) Employment on a SPWP does not qualify as employment as a contributor for the purpose of the Unemployment Insurance Act 30 of 1966.</li> </ul>

<b>SCC 59.3.3</b>	<p><b>Normal Hours of Work</b></p> <p>(a) An Employer may not set tasks or hours of work that require a worker to work–</p> <ul style="list-style-type: none"> <li>(i) more than forty hours in any week</li> <li>(ii) on more than five days in any week; and</li> <li>(iii) for more than eight hours on any day.</li> </ul> <p>(b) An Employer and worker may agree that a worker will work four days per week. The worker may then work up to ten hours per day.</p> <p>(c) A task-rated worker may not work more than a total of 55 hours in any week to complete the tasks allocated (based on a 40-hour week) to that worker.</p>
<b>SCC 59.3.4</b>	<p><b>Meal Breaks</b></p> <p>(a) <b>A worker may not work for more than five hours without taking a meal break of at least thirty minutes duration.</b></p> <p>(b) An Employer and worker may agree on longer meal breaks.</p> <p>(c) A worker may not work during a meal break. However, an Employer may require a worker to perform duties during a meal break if those duties cannot be left unattended and cannot be performed by another worker. An Employer must take reasonable steps to ensure that a worker is relieved of his or her duties during the meal break.</p> <p>(d) A worker is not entitled to payment for the period of a meal break. However, a worker who is paid on the basis of time worked must be paid if the worker is required to work or to be available for work during the meal break.</p>
<b>SCC 59.3.5</b>	<p><b>Special Conditions for Security Guards</b></p> <p>(a) A security guard may work up to 55 hours per week and up to eleven hours per day.</p> <p>(b) A security guard who works more than ten hours per day must have a meal break of at least one hour or two breaks of at least 30 minutes each.</p>
<b>SCC 59.3.6</b>	<p><b>Daily Rest Period</b></p> <p>Every worker is entitled to a daily rest period of at least eight consecutive hours. The daily rest period is measured from the time the worker ends work on one day until the time the worker starts work on the next day.</p>
<b>SCC 59.3.7</b>	<p><b>Weekly Rest Period</b></p> <p>Every worker must have two days off every week. A worker may only work on their day off to perform work which must be done without delay and cannot be performed by workers during their ordinary hours of work (“emergency work”).</p>
<b>SCC 59.3.8</b>	<p><b>Work on Sundays and Public Holidays</b></p> <p>(a) A worker may only work on a Sunday or Public holiday to perform emergency or security work.</p> <p>(b) Work on Sundays is paid at the ordinary rate of pay.</p> <p>(c) A task-rated worker who works on a public holiday must be paid –</p>

	<ul style="list-style-type: none"> <li>(i) the worker’s daily task rate, if the worker works for less than four hours;</li> <li>(ii) double the worker’s daily task rate, if the worker works for more than four hours.</li> </ul> <p>(d) A time-rated worker who works on a public holiday must be paid –</p> <ul style="list-style-type: none"> <li>(i) the worker’s daily rate of pay, if the worker works for less than four hours on the public holiday;</li> <li>(ii) double the worker’s daily rate of pay, if the worker works for more than four hours on the public holiday.</li> </ul>
<p><b>SCC 59.3.9</b></p>	<p><b>Sick Leave</b></p> <ul style="list-style-type: none"> <li>(a) Only workers who work four or more days per week have the right to claim sick-pay in terms of this clause.</li> <li>(b) A worker who is unable to work on account of illness or injury is entitled to claim one day’s paid sick leave for every full month that the worker has worked in terms of a Contract.</li> <li>(c) A worker may accumulate a maximum of twelve days’ sick leave in a year.</li> <li>(d) Accumulated sick-leave may not be transferred from one Contract to another Contract.</li> <li>(e) An Employer must pay a task-rated worker the worker’s daily task rate for a day’s sick leave.</li> <li>(f) An Employer must pay a time-rated worker the worker’s daily rate of pay for a day’s sick leave.</li> <li>(g) An Employer must pay a worker sick pay on the worker’s usual payday.</li> <li>(h) Before paying sick-pay, an Employer may require a worker to produce a certificate stating that the worker was unable to work on account of sickness or injury if the worker is–             <ul style="list-style-type: none"> <li>(i) absent from work for more than two consecutive days; or</li> <li>(ii) absent from work on more than two occasions in any eight-week period.</li> </ul> </li> <li>(i) A medical certificate must be issued and signed by a Medical Practitioner, a qualified Nurse or a Clinic staff member authorised to issue medical certificates indicating the duration and reason for incapacity.</li> <li>(j) A worker is not entitled to paid sick-leave for a work-related injury or occupational disease for which the worker can claim compensation under the Compensation for Occupational Injuries and Diseases Act.</li> </ul>
<p><b>SCC 59.3.10</b></p>	<p><b>Maternity Leave</b></p> <ul style="list-style-type: none"> <li>(a) A worker may take up to four consecutive months’ unpaid maternity leave.</li> <li>(b) A worker is not entitled to any payment or employment-related benefits during maternity leave.</li> <li>(c) A worker must give her Employer reasonable notice of when she will start maternity leave and when she will return to work.</li> </ul>

	<p>(d) A worker is not required to take the full period of maternity leave. However, a worker may not work for four weeks before the expected date of birth of her child or for six weeks after the birth of her child, unless a medical practitioner, midwife or qualified nurse certifies that she is fit to do so.</p> <p>(e) A worker may begin maternity leave –</p> <p>(i) four weeks before the expected date of birth; or</p> <p>(ii) on an earlier date –</p> <p>(1) if a medical Practitioner, Midwife or Certified Nurse certifies that it is necessary for the health of the worker or that of her unborn child; or</p> <p>(2) if agreed to between Employer and worker; or</p> <p>(iii) on a later date, if a medical Practitioner, Midwife or Certified nurse has certified that the worker is able to continue to work without endangering her health.</p> <p>(f) A worker who has a miscarriage during the third trimester of pregnancy or bears a stillborn child may take maternity leave for up to six weeks after the miscarriage or stillbirth.</p> <p>(g) A worker who returns to work after maternity leave has the right to start a new cycle of twenty-four months employment, unless the SPWP on which she was employed has ended.</p>
<p><b>SCC 59.3.11</b></p>	<p><b>Family responsibility leave</b>              Workers, who work for at least four days per week, are entitled to three days paid family responsibility leave each year in the following circumstances –</p> <p>(a) when the employee’s child is born;</p> <p>(b) when the employee’s child is sick;</p> <p>(c) in the event of a death of –</p> <p>(i) the employee’s spouse or life partner;</p> <p>(ii) the employee’s parent, adoptive parent, grandparent, child, adopted child, grandchild or sibling.</p>
<p><b>SCC 59.3.12</b></p>	<p><b>Statement of Conditions</b></p> <p>(a) An Employer must give a worker a statement containing the following details at the start of employment –</p> <p>(i) the Employer’s name and address and the name of the SPWP;</p> <p>(ii) the tasks or job that the worker is to perform; and</p> <p>(iii) the period for which the worker is hired or, if this is not certain, the expected duration of the Contract;</p> <p>(iv) the worker’s rate of pay and how this is to be calculated;</p> <p>(v) the training that the worker will receive during the SPWP.</p> <p>(b) An Employer must ensure that these terms are explained in a suitable language to any employee who is unable to read the statement.</p> <p>(c) An Employer must supply each worker with a copy of these Conditions of employment.</p>

<b>SCC 59.3.13</b>	<b>Keeping Records</b>  (a) Every Employer must keep a written record of at least the following –  (i) the worker’s name and position;  (ii) in the case of a task-rated worker, the number of tasks completed by the worker;  (iii) in the case of a time-rated worker, the time worked by the worker;  (iv) payments made to each worker.  (b) The Employer must keep this record for a period of at least three years after the completion of the SPWP.
<b>SCC 59.3.14</b>	<b>Payment</b>  (a) An Employer must pay all wages at least monthly in cash or by cheque or into a bank account.  (b) A task-rated worker will only be paid for tasks that have been completed.  (c) An Employer must pay a task-rated worker within five weeks of the work being completed and the work having been approved by the manager or the Contractor having submitted an invoice to the Employer.  (d) A time-rated worker will be paid at the end of each month.  (e) Payment must be made in cash, by cheque or by direct deposit into a bank account designated by the worker.  (f) Payment in cash or by cheque must take place –  (i) at the workplace or at a place agreed to by the worker;  (ii) during the worker’s working hours or within fifteen minutes of the start or finish of work;  (iii) in a sealed envelope which becomes the property of the worker.  (g) An Employer must give a worker the following information in writing –  (i) the period for which payment is made;  (ii) the numbers of tasks completed or hours worked;  (iii) the worker’s earnings;  (iv) any money deducted from the payment;  (v) the actual amount paid to the worker.  (h) If the worker is paid in cash or by cheque, this information must be recorded on the envelope and the worker must acknowledge receipt of payment by signing for it  (i) If a worker’s employment is terminated, the Employer must pay all monies owing to that worker within one month of the termination of employment.

<b>SCC 59.3.15</b>	<p><b>Deductions</b></p> <ul style="list-style-type: none"> <li>(a) An Employer may not deduct money from a worker’s payment unless the deduction is required in terms of a law.</li> <li>(b) An Employer must deduct and pay to the SA Revenue Services any income tax that the worker is required to pay.</li> <li>(c) An Employer who deducts money from a worker’s pay for payment to another person must pay the money to that person within the time period and other requirements specified in the agreement law, court order or arbitration award concerned.</li> <li>(d) An Employer may not require or allow a worker to –             <ul style="list-style-type: none"> <li>(i) repay any payment except an overpayment previously made by the Employer by mistake;</li> <li>(ii) state that the worker received a greater amount of money than the Employer actually paid to the worker; or</li> <li>(iii) pay the Employer or any other person for having been employed.</li> </ul> </li> </ul>
<b>SCC 59.3.16</b>	<p><b>Health and Safety</b></p> <ul style="list-style-type: none"> <li>(a) Employers must take all reasonable steps to ensure that the working environment is healthy and safe.</li> <li>(b) A worker must –             <ul style="list-style-type: none"> <li>(i) work in a way that does not endanger his/her health and safety or that of any other person;</li> <li>(ii) obey any health and safety instruction;</li> <li>(iii) obey all health and safety rules of the SPWP;</li> <li>(iv) use any personal protective equipment or clothing issued by the Employer;</li> <li>(e) report any accident, near-miss incident or dangerous behaviour by another person to their Employer or manager.</li> </ul> </li> </ul>
<b>SCC 59.3.17</b>	<p><b>Compensation for Injuries and Diseases</b></p> <ul style="list-style-type: none"> <li>(a) It is the responsibility of the Employers (other than a Contractor) to arrange for all persons employed on a SPWP to be covered in terms of the Compensation for Occupational Injuries and Diseases Act, 130 of 1993.</li> <li>(b) A worker must report any work-related injury or occupational disease to their Employer or manager.</li> <li>(c) The Employer must report the accident or disease to the Compensation Commissioner.</li> <li>(d) An Employer must pay a worker who is unable to work because of an injury caused by an accident at work 75% of their earnings for up to three months. The Employer will be refunded this amount by the Compensation Commissioner. This does NOT apply to injuries caused by accidents outside the workplace such as road accidents or accidents at home.</li> </ul>

<b>SCC 59.3.18</b>	<b>Termination</b>  (a) The Employer may terminate the employment of a worker for good cause after following a fair procedure.  (b) A worker will not receive severance pay on termination.  (c) A worker is not required to give notice to terminate employment. However, a worker who wishes to resign should advise the Employer in advance to allow the Employer to find a replacement.  (d) A worker who is absent for more than three consecutive days without informing the Employer of an intention to return to work will have terminated the Contract. However, the worker may be re-engaged if a position becomes available for the balance of the 24-month period.  (e) A worker who does not attend required training events, without good reason, will have terminated the Contract. However, the worker may be re-engaged if a position becomes available for the balance of the 24-month period.
<b>SCC 59.3.19</b>	<b>Certificate of Service</b>  On termination of employment, a worker is entitled to a certificate stating –  (i) the worker’s full name; (ii) the name and address of the Employer; (iii) the SPWP on which the worker worked; (iv) the work performed by the worker; (v) any training received by the worker as part of the SPWP; (vi) the period for which the worker worked on the SPWP; (vii) any other information agreed on by the Employer and worker.
<b>SCC 59.3.20</b>	<b>Reporting</b>  The Contractor shall report the breakdown of each payment certificate into the broad categories of:  a) Overheads, b) Supervision, c) Materials, d) Plant, and e) Labour.  The Contractor shall further report for each payment certificate the person-days of employment as set out in the Pro Forma, Schedule X: Monthly Labour Report.  In the calculation of person-days, a day shall be taken as 8 hours and no time over and above 8 hours per day shall be used to contribute to the number of person-days reported.
<b>SCC 59.3.21</b>	<b>Source of Labour</b>  The Contractor shall source his labour from the local area through the services of an appropriate Councillor or Community Liaison Officer or another appointed person who has contact with a labour pool in the area.

**4. TRANSFER OF RIGHTS**

The successful tenderer should complete and submit a Transfer of Rights Form to claim for materials on site with every progress payment for the project. No payment for materials on site would be granted if this Document is not submitted with the progress payment being considered.

**TRANSFER OF RIGHTS**

**TRANSFER OF RIGHTS AND INDEMNITY (To be completed during construction by successful Tenderer only)**

**Claim for materials on site, Payment Certificate No.** ..... **Date:** .....

**Contract No:** ..... For (Contract title) .....

I, the undersigned (name of signatory) ..... in my capacity as

..... of (name of Contractor) .....

duly authorised hereto on behalf of the Contractor hereby transfer, cede and assign all the Contractor’s rights, title and interest in and to the materials and goods, for which evidence of bona fide ownership is attached hereto, unto and in favour of (name of Employer) ..... insofar as the Contractor retains actual control of the materials and goods, the right of ownership thereof passes to the Employer by *constitutum possessorium*.

I herewith indemnify the Employer against any claim to and in respect of said materials by reason of the Contractor’s sequestration or liquidation or of any defect in the Contractor’s title to the materials and agree that no payment for materials on site will be made by the Employer until such time as I have submitted documentary proof of bona fide ownership of the said materials and goods.

This transfer shall become effective upon conclusion of the Contractor receiving payment from the Employer or from any other person on behalf of the Employer for the materials and goods as Materials on Site, payment of retention money thereon excluded.

I further confirm that I am fully responsible for all materials and goods listed under this Transfer of Rights and that they have been insured adequately against all risks and will remain insured until they are built into or used in the permanent works and taken over by the Employer.

**This certificate of Transfer of Rights applies only to the materials and goods as listed in the following table.**

Description of Item	Unit	Quantity	Rate	Amount	Supplier
Total Value of Materials and goods					

**Signed by:** ..... **Date:** .....  
 for and on behalf of the Contractor.

**Witnessed by:** ..... **Date:** .....

**NOTE:** This form, together with the documentary proof of ownership or proof of payment by the Contractor to the supplier, shall accompany the Contractor’s claim for payment for materials on site in terms of Clause 49.1.5 of the General Conditions of Contract 2004.



## C1.2.2 PART A: DATA PROVIDED BY THE EMPLOYER

The following Contract Specific Data are applicable to this Contract.

### REFERENCE CONTRACT SPECIFIC DATA BY THE EMPLOYER

Clause 1.1.14: **Name of Employer:** Limpopo Department of Agriculture & Rural Development, Polokwane

Clause 1.2.2: **Address of Employer:**

Physical:

Limpopo Department of Agriculture  
& Rural Development  
69 Biccard Street  
Polokwane  
0700

Postal:

Limpopo Department of Agriculture  
& Rural Development  
P Bag X9487  
Polokwane  
0700

E-Mail:

Telephone No: (015) 294 3000

Fax No: (015) 294 4535

Clause 1.1.15: **Name of Engineer:** Mr L Nemakhavhani

Clause 1.2.2: **Address of Engineer:**

Physical:

Limpopo Department of Agriculture  
& Rural Development  
Makwarela Government Complex  
Sibasa  
0970

Postal:

Limpopo Department of Agriculture  
& Rural Development  
P Bag X2247  
Sibasa  
0970

E-Mail: [lnemakhavhanil@agric.limpopo.gov.za](mailto:lnemakhavhanil@agric.limpopo.gov.za)

Telephone No: (015) 963 2005 Fax No: (015) 963 2014

Clause 1.6 & 38.1: Special non-working days are Sundays and the following statutory public holidays as declared by National or Regional Government:

New Year's Day, Human Rights Day, Good Friday, Family Day, Freedom Day, Workers day, Youth Day, National Women's Day, Heritage Day, Day of Reconciliation, Christmas Day and the Day of Goodwill including the construction industry year end break.

Clause 1.6: The year end break commences on the first working day after 15 December and ends on the first working day after 5 January of the next year.

Clause 2.3: The Engineer is required to obtain the specific approval of the Employer for the following:

The Engineer requires Departmental approval in order to authorise any expenditure in excess of the Tender Sum plus 15% Contingencies.

Clause 7: Performance Guarantee to be delivered within 14 days of the Commencement Day.

The total liability under the guarantee should not be less than 10% of the tender amount, excluding VAT.

Clause 10.1: The Contractor shall commence executing the work within 14 days of the Commencement

- 
- date.
- Clause 12.2: The Contractor shall deliver his programme of work within 14 days of the Commencement date.
- Clause 35.1.1.2.2: The value of material to be supplied by the Employer is nil.
- Clause 35.1.1.2.3: The amount to cover Professional fees for repairing damage and loss to be included in the Insurance sum is R 150 000.00
- Clause 35.1.3: The limit of indemnity for Liability Insurance is R 5 000 000.00 for any single liability claim. Liability insurance shall include spread of fire risk.
- Clause 37.2.2.3: The percentage allowance to cover overhead charges is 15%.
- Clause 42.1: The Works shall be completed within **5 MONTHS** excluding special non-working days and the year-end break.
- Clause 43.1: The penalty for failing to complete the works is 0.05% of the Total Tender Sum per Calendar Day.
- Clause 46: No Contract Price Adjustment will be allowed for this Contract.
- Clause 49.1.5: The percentage advance on materials not yet built into the Permanent Works is: 80%
- Clause 49.3: The percentage retention on the amounts due to the Contractor is 10 %, excluding Contract Price Adjustment, Contingencies and VAT, and limited to 5% of the Contract amount, excluding Contract Price Adjustment, Contingencies and VAT.
- Clause 49.6: A Retention money Guarantee will **not** be permitted.
- Clause 53.1: The Defects Liability Period is 12 months measured from the date of the Certificate of Completion. And a guarantee of 12 months.
- Clause 58.1.4 Dispute resolution shall be by Adjudication.
- Clause 58.3: Dispute Resolution shall be by Adjudication.

**C1.2.2: PART B: DATA PROVIDED BY THE CONTRACTOR**

The following Contract Specific Data are applicable to this Contract:

**REFERENCE CONTRACT SPECIFIC DATA BY THE CONTRACTOR**

Clause 1.1.8: **Name of Contractor:** .....

Clause 1.2.2: **Address of the Contractor:**

Physical:

Postal:

.....

.....

.....

.....

.....

.....

.....

.....

E-Mail: .....

Telephone No: .....

Fax No: .....

Clause 46.3: The variation in cost of all special materials is to be provided in the table SM 1 for special materials.

The rates and prices for the special materials shall be furnished by the Tenderer, which rates and prices shall not include VAT but shall include all other obligatory taxes and levies. **The quoted price is the ruling price on the Month prior to close of tender.**

**TABLE: SM1**

Special material	Unit on which variation will be determined		Price for base month ex factory, excluding transport, labour or any other costs.
	Containers	Delivered in bulk	

\* Contractor to indicate the type, unit and rate of special material to be listed. When called upon to do so, the Contractor shall substantiate the above rates or prices with acceptable documentary evidence. Contractor to provide any other Special Materials if deemed necessary

**C1.3 FORM OF GUARANTEE - PRO FORMA**

Contract No.  
WHEREAS **The Limpopo Department of Agriculture and Rural Development** (hereinafter referred to as the Employer”) entered into, a Contract with:

.....  
(Hereinafter called “the Contactor”) on the ..... day of ..... 20.....

for **CONSTRUCTION OF CHILI PEPPER DRYING FACILITY AT ROYAL FIELD FARM UNDER MUSINA LOCAL MUNICIPALITY IN VHEMBE DISTRICT OF LIMPOPO PROVINCE**

AND WHEREAS it is provided by such Contract that the Contractor shall provide the Employer with security by way of a Guarantee for the due and faithful fulfilment of such Contract by the Contractor;

AND WHEREAS ..... has / have at the request of the Contractor, agreed to give such Guarantee;

NOW THEREFORE WE ..... do hereby Guarantee and bind ourselves jointly and severally as Guarantor and Co-principal Debtors to the Employer under renunciation of the benefits of division and execution for the due and faithful performance by the Contractor of all the Terms and Conditions of the said Contract, subject to the following Conditions:

1. The Employer shall, without reference and / or notice to us, have complete liberty of action to act in any manner authorized and/or contemplated by the terms of the said Contract, and/or to agree to any modifications, variations, alterations, directions or extensions of the completion date of the works under the said Contract, and that its rights under this Guarantee shall in no way be prejudiced nor our liability hereunder be affected by reason of any steps which the Employer may take under such Contract, or of any modification, variation, alterations of the completion date which the Employer may make, give, concede or agree to under the said Contract.
2. This Guarantee shall be limited to the payment of a sum of money.
3. The Employer shall be entitled, without reference to us, to release any Guarantee held by it, and to give time to or compound or make any other arrangement with the Contractor.
4. This Guarantee shall remain in full force and effect until the issue of the Certificate of Completion in terms of the Contract, unless we are advised in writing by the Employer before the issue of the said Certificate of his intention to institute claims, and the particulars thereof, in which event this Guarantee shall remain in full force and effect until all such claims have been paid or liquidated.
5. Our total liability hereunder shall not exceed the Guaranteed Sum of:  
.....  
.....Rand (in words);  
R. .... (in figures)
6. The Guarantor reserves the right to withdraw from this Guarantee by depositing the Guaranteed Sum with the beneficiary, whereupon our liability hereunder shall cease.
7. We hereby choose our address for the serving of all notices for all purposes arising here from as

.....  
.....  
.....

.....

IN WITNESS WHEREOF this Guarantee has been executed by us at .....  
on this ..... day of ..... 20 .....

Signature .....

Duly authorized to sign on behalf of .....

Address .....  
.....  
.....

As witnesses:

1 .....

2 .....

**C1.4: AGREEMENT IN TERMS OF SECTION 37(2) OF THE OCCUPATIONAL HEALTH AND SAFETY ACT NO 85 OF 1993**

THIS AGREEMENT is made between **The Limpopo Department of Agriculture and Rural Development**  
(hereinafter called the EMPLOYER of the one part, herein represented by:

.....  
in his capacity as: .....

AND: .....

(hereinafter called the CONTRACTOR) of the other part, herein represented by .....

.....  
in his capacity as: .....

duly authorised to sign on behalf of the Contractor.

WHEREAS the CONTRACTOR is the Mandatory of the EMPLOYER in consequence of an Agreement between the CONTRACTOR and the EMPLOYER in respect of

**CONTRACT No: ACDP 23/05: CONSTRUCTION OF CHILI PEPPER DRYING FACILITY AT ROYAL FIELD FARM UNDER MUSINA LOCAL MUNICIPALITY IN VHEMBE DISTRICT OF LIMPOPO PROVINCE**

AND WHEREAS the EMPLOYER and the CONTRACTOR have agreed to enter into an agreement in terms of the provisions of Section 37(2) of the Occupational Health and Safety Act No 85 of 1993, as amended by OHS Act Amendment Act No 181/1993 (hereinafter referred to as the ACT);

**NOW THEREFORE** the parties agree as follows:

1. **The CONTRACTOR undertakes to acquaint the appropriate officials and employees of the CONTRACTOR with all relevant provisions of the ACT and the regulations promulgated in terms thereof.**
2. The CONTRACTOR undertakes to fully comply with all relevant duties, obligations and prohibitions imposed in terms of the ACT and Regulations: Provided that should the EMPLOYER have prescribed certain arrangements and procedures that same shall be observed and adhered to by the CONTRACTOR, his officials and employees. The CONTRACTOR shall bear the onus of acquainting himself/herself/itself with such arrangements and procedures.
3. The CONTRACTOR hereby accepts Sole Liability for such due compliance with the relevant duties, obligations, prohibitions, arrangements and procedures, if any, imposed by the ACT and Regulations, and the CONTRACTOR expressly absolves the EMPLOYER and the Employer's CONSULTING ENGINEERS from being obliged to comply with any of the aforesaid duties, obligations, prohibitions, arrangements and procedures in respect of the work included in the Contract.
4. The CONTRACTOR agrees that any duly authorised officials of the EMPLOYER shall be entitled, although not obliged, to take such steps as may be necessary to ensure that the CONTRACTOR has complied with his undertakings as more fully set out in paragraphs 1 and 2 above, which steps may include, but shall not be limited to, the right to inspect any appropriate site or premises occupied by the CONTRACTOR, or to take such steps it may deem necessary to remedy the default of the CONTRACTOR at the cost of the CONTRACTOR.
5. The CONTRACTOR shall be obliged to report forthwith to the EMPLOYER any investigation, complaint or criminal charge which may arise as a consequence of the provisions of the ACT and Regulations, pursuant to work performed in terms of this agreement, and shall, on written demand, provide full details in writing of such investigation, complaint or criminal charge.

---

Thus signed at ..... for and on behalf of the CONTRACTOR

on this the ..... day of ..... 20.....

SIGNATURE: .....

NAME AND SURNAME: .....

CAPACITY: .....

WITNESSES: 1. ....

2. ....

Thus signed at ..... for and on behalf of the EMPLOYER on this

the ..... day of ..... 20.....

SIGNATURE: .....

NAME AND SURNAME: .....

CAPACITY: .....

WITNESSES: 1. ....

2. ....

---

## **PART C2: PRICING DATA**

### **C2.1: PRICING INSTRUCTIONS**

### **C2.2: BILL OF QUANTITIES**



## LIMPOPO DEPT OF AGRICULTURE AND RURAL DEVELOPMENT

### CONSTRUCTION OF CHILI PEPPER DRYING FACILITY AT ROYAL FIELDS FARM UNDER MUSINA LOCAL MUNICIPALITY IN VHEMBE DISTRICT OF LIMPOPO PROVINCE

#### C2.1 Pricing Instructions

1. Measurement and payment shall be in accordance with the relevant provisions of the General Conditions of Contract (2010 edition) as amended in the Scope of Works.
2. The units of measurement described in this Bill of Quantities are metric units. Abbreviations used in the Bill of Quantities are as follows:

%	=	percent
h	=	hour
ha	=	hectare
kg	=	kilogram
kl	=	kilolitre
km	=	kilometre
km-pass	=	kilometre-pass
kPa	=	kilopascal
kW	=	kilowatt
l	=	litre
m	=	metre
mm	=	millimetre
m <sup>2</sup>	=	square metre
m <sup>2</sup> -pass	=	square metre-pass
m <sup>3</sup>	=	cubic metre
m <sup>3</sup> -km	=	cubic metre-kilometre
MN	=	meganewton
MN.m	=	meganewton-metre
MPa	=	megapascal
No.	=	number
Prov sum	=	Provisional sum
PC sum	=	Prime Cost sum
R/only	=	Rate only
sum	=	lump sum
t	=	ton (1000 kg)
W/day	=	Work day

3. For the purpose of this Bill of Quantities, the following words shall have the meanings hereby assigned to them:

Unit:	The unit of measurement for each item of work as defined in the Specifications
Quantity:	The number of units of work for each item.
Rate:	The agreed payment per unit of measurement.
Amount:	The product of the quantity and the agreed rate for an item.
Lump sum:	An agreed amount for an item, the extent of which is described in the Bills of Quantities but the quantity of work of which is not measured in any units.

4. Unless otherwise stated, items are measured net in accordance with the Drawings, and no allowance is made for waste.
5. The prices and rates in this Bill of Quantities are fully inclusive prices for the Work described under the items. Such prices and rates cover all costs and expenses that may be required in and for the execution of the Work described in accordance with the provisions of the Scope of Work, and shall cover the cost of all general risks, liabilities, and obligations set forth or implied in the Contract Data, as well as overhead charges and profit. These prices will be used as a basis for assessment of payment for additional Work that may have to be carried out.

6. It will be assumed that prices included in the Bill of Quantities are based on Acts, Ordinances, Regulations, By-laws, International Standards and National Standards that were published 28 days before the closing date for Tenders. (Refer to [www.stanza.org.za](http://www.stanza.org.za) or [www.iso.org](http://www.iso.org) for information on Standards)
7. Where the Scope of Work requires detailed Drawings and designs or other information to be provided, all costs associated therewith are deemed to have been provided for and included in the unit rates and sum amount Tendered such items
8. An item against which no price is entered will be considered to be covered by the other prices or rates in the Bill of Quantities. A single Lump Sum will apply should a number of items be grouped together for pricing purposes.
9. The quantities set out in this Bill of Quantities are approximate and do not necessarily represent the actual amount of Work to be done. The quantities of work accepted and Certified for Payment will be used for determining payments due and not the quantities given in this Bill of Quantities.
10. The short descriptions of the items of payment given in this Bill of Quantities are only for the purposes of identifying the items. More details regarding the extent of the work entailed under each item appear in the Scope of Work.
11. The item numbers appearing in the Bills of Quantities refer to the corresponding item numbers in the Specifications were applicable.
12. Those parts of the contract to be constructed using labour-intensive methods have been marked in the Bills of Quantities with the letters "LI" in a separate column filled in against every item so designated. The works, or parts of the works so designated are to be constructed using labour-intensive methods only. The use of plant to provide such works, other than plant specifically provided for in the scope of work, is a variation to the contract. The items marked with the letters LI are not necessarily an exhaustive list of all the activities which must be done by hand, and this clause does not over-ride any of the requirements in the generic labour intensive specification in the Scope of Works.
13. Payment for items which are designated to be constructed labour-intensively (either in this schedule or in the Scope of Works) will not be made unless they are constructed using labour-intensive methods. Any unauthorised use of plant to carry out work which was to be done labour-intensively will not be condoned and any works so constructed will not be certified for payment.

**LIMPOPO DEPT OF AGRICULTURE AND RURAL DEVELOPMENT**  
**CONSTRUCTION OF CHILI PEPPER DRYING FACILITY AT ROYAL FIELDS FARM**  
**UNDER MUSINA LOCAL MUNICIPALITY IN VHEMBE DISTRICT OF LIMPOPO PROVINCE**

**C2.2 Bill of Quantities**

BILL OF QUANTITIES:  
CONSTRUCTION OF CHILI PEPPER DRYING FACILITY AT ROYAL FIELDS FARM

**LIMPOPO DEPARTMENT OF AGRICULTURE AND RURAL DEVELOPMENT**



**LIMPOPO**  
PROVINCIAL GOVERNMENT  
REPUBLIC OF SOUTH AFRICA

**DEPARTMENT OF  
AGRICULTURE AND RURAL DEVELOPMENT**

**CONSTRUCTION OF CHILI PEPPER DRYING FACILITY AT ROYAL FIELDS FARM UNDER MUSINA LOCAL  
MUNICIPALITY IN VHEMBE DISTRICT OF LIMPOPO PROVINCE**

**Preliminary and Generals**

Item No	Payment	DESCRIPTION	UNIT	QTY	RATE	AMOUNT
<b>SECTION A: Preliminary and Generals</b>						
		<b>SCHEDULED FIXED CHARGE AND VALUE RELATED ITEMS</b>				
A1		<b>Fixed Preliminary and General Charges:</b> All fixed charge contractual requirements not limited to contract administration, safety, site establishment, tools and equipment, sanitation, accomodation, power and portable water,telephone, transport, deestablishment, etc	sum	1		
A2		Value Related Preliminary and General Charges. All value charge	sum	1		
A3		<b>SCHEDULED TIME-RELATED ITEMS</b> Time Related Preliminary and General ChargesAll time related contractual requirements not limited to contract administration, safety, site establishment, insurance, sanitation, tools and equipment, accomodation, power and portable water,telephone, transport, deestablishment, health and saftey obligations etc	Month	5		
A4		<b>PROVISIONS BY THE ENGINEER</b>				
A4.1		CLO	Month	5	5000	25000
A4.2		Mark-up on provisional sums	%	25000		
A4.3		Testing of services as directed by the engineer	Prov Sum	1	10000	10000
A4.4		Overheads, charges and profit on subitems above	%	10000		
A4.5		Works executed by Nominated Subcontractors (ESKOM)	Prov Sum	1	800000	800000
A4.6		Overheads, charges and profit on subitems above	%	800000		
Total Carried Forward To Forward						

LIMPOPO DEPARTMENT OF AGRICULTURE AND RURAL DEVELOPMENT



**LIMPOPO**  
PROVINCIAL GOVERNMENT  
REPUBLIC OF SOUTH AFRICA

**DEPARTMENT OF  
AGRICULTURE AND RURAL DEVELOPMENT**

**CONSTRUCTION OF CHILI PEPPER DRYING FACILITY AT ROYAL FIELDS FARM UNDER MUSINA LOCAL MUNICIPALITY IN  
Preliminary and Generals**

Item No	Payment	DESCRIPTION	UNIT	QTY	RATE	AMOUNT
<b>SECTION A: Preliminary and Generals</b>						
<b>Brought forward</b>						
A5		<b><u>Occupational Health and Safety</u></b>				
A5.1		Without limiting the generality of the provisions, of clause 4.3.1 of the GCC second edition 2010, the contractor's attention is drawn to the provisions of the following regulations: Construction Regulations, 2014 issued in terms of the Occupational Health and Safety Act (Act No 85 of 1993) as amended. The employer reserves the right to take any action should any of the breaches on above regulations and / or the Employer's Requirements come to their notice, including the provision of and insistence on the use of hard hats, overalls, ear protection plugs, eye protection goggles, reflective safety vests, gloves, safety boots, belted safety harnesses, etc by any person on the site, the cost for purchase of which will be borne by the purchase of which will be borne by the contractor.	Sum	1		
A6		<b>Environmental Management Plan Adhering to the requirements as set out in Section C3.3 Part D</b>	Sum	1		
A7		<b>Auditing of Compliance by the Contractor to the</b>				
A7.1		Provisional sum for appointment of OSH auditor on behalf of the LDARD to conduct monthly visits as well as present reports at monthly meeting	Prov Sum	1	50000	50000
A7.2		Overheads, charges and profit on item above	%	50000		
Total Carried Forward To Summary						

**LIMPOPO DEPARTMENT OF AGRICULTURE AND RURAL DEVELOPMENT**



**LIMPOPO**  
PROVINCIAL GOVERNMENT  
REPUBLIC OF SOUTH AFRICA

**DEPARTMENT OF AGRICULTURE AND RURAL DEVELOPMENT**

**OF LIMPOPO PROVINCE**

Item No	Payment	DESCRIPTION	UNIT	QTY	RATE	AMOUNT
<b>SECTION B: BUILDING WORKS</b>						
B1		<b>Carry out the following operation as applicable: Manufacture, supply, deliver, install, commission, test and attend to defects for the following items:</b>				
		<b>EARTHWORKS</b>				
B1.1		Clear and grub	m <sup>2</sup>	300		
B1.2		Remove and grub large trees and tree stumps of girth: up to 1,0 m	No	2		
B1.3		Remove topsoil to nominal depth of 150 - 200 mm and stockpile or dispose (as directed by Engineer)	m <sup>2</sup>	300		
B1.4		Excavate foundation to hard soil, 600x600 mm	m <sup>3</sup>	26		
B1.5		Excavate for footing to hard soil, 1200x700 mm	m <sup>3</sup>	11		
B1.6		Spray cleaned area up to 2m outside the building perimeter and inside trenches with pesticide to prevent termites from nesting	m <sup>2</sup>	320		
B1.7		Stock pile waste material on site to be determined by engineer	m <sup>3</sup> /km	5		
B2		<b>Earth filling (G7 material) supplied by the contractor compacted to 98% Mod AASHTO density</b>				
B2.1		Under floors	m <sup>3</sup>	90		
B2.2		Termite treatment or soil poisoning by safe and effective specialist with Chlordane or Aldrin type termite soil insecticide all in accordance with SABS 0124-1977: Under solid floors including forming furrows against foundation walls, etc. and filling in furrows	m <sup>2</sup>	180		
B3	SABS 1200 G	<b>REINFORCED CONCRETE CAST AGAINST EXCAVATED SURFACES</b>				
B3.1		<b>SMOOTH FORMWORK (DEGREE OF ACCURACY II)</b>				
B3.1.1		Columns	m <sup>2</sup>	30		
B3.2		<b>25MPa/19mm concrete</b>				
B3.2.1		Bases, strip footings, columns, surface beds	m <sup>3</sup>	60		
B3.3		<b>15Mpa/19mm concrete</b>				
B3.3.1		Blinding layer under bases, apron	m <sup>3</sup>	15		
B4		<b>REINFORCEMENT</b>				
B4.1		Mild and high steel reinforcement to structural concrete work Type 245 fabric reinforcement in concrete surface beds	m <sup>2</sup>	180		
B4.2		Weld mesh brickforce on every second row foundation and third row on super structure in the following width a) 230 mm	m	690		
B5		<b>SCREEDS</b>				
B5.1		<b>Cement screed finished with a steel float</b> 40mm Average thick screed to floors to falls	m <sup>2</sup>	180		
Total Carried Forward						

LIMPOPO DEPARTMENT OF AGRICULTURE AND RURAL DEVELOPMENT



**LIMPOPO**  
PROVINCIAL GOVERNMENT  
REPUBLIC OF SOUTH AFRICA

**DEPARTMENT OF  
AGRICULTURE AND RURAL DEVELOPMENT**

CONSTRUCTION OF CHILI PEPPER DRYING FACILITY AT ROYAL FIELDS FARM UNDER MUSINA LOCAL MUNICIPALITY IN VHEMBE DISTRICT OF LIMPOPO PROVINCE

Item No	Payment	DESCRIPTION	UNIT	QTY	RATE	AMOUNT
<b>SECTION B: BUILDING WORKS</b>						
<b>brought forward</b>						
B6		<b>BRICKWORK</b> All bricks to be SANS approved. Price to include supply, transport to site including all mortar, pointing, scaffolding and support.				
		Point finished face bricks: Nebraska Travertine face bricks or similar approved, pointed with recessed horizontal and vertical joints				
B6.1		a) 230 mm wide brick wall	m <sup>2</sup>	105		
		Walling with clay stock bricks on the inside (NFP type) and pointed finish face bricks on the outside (FBS type), all to SANS 227				
B6.2		a) Point finished face bricks on the outside of the wall	m <sup>2</sup>	34		
B6.3		b) Stock clay bricks on the inside of the double wall	m <sup>2</sup>	33		
		Walling with clay stock bricks on the foundation(NFP type)				
B6.4		a) 230 mm wide brick wall	m <sup>2</sup>	25		
B7		<b>WATERPROOFING</b> One layer of 250 micron "Consol Plastics Gunplas USB Green" waterproof sheeting sealed at laps with "Gunplas Pressure Sensitive Tape"				
B7.1		Under surface bed	m <sup>2</sup>	180		
		One layer of 375 micron "Consol Plastics Brikgrip DPC" embossed damp proof course				
B7.2		In 230 mm walls	m	21		
B8		<b>Capentry</b> <b>Doors</b>				
		Supply & install standard heavy duty double solid wooden door with steel frame, complete with Cylinder sashlock CP lock, chromium plated handles, door stoppers				
B8.1		a) 1613 x 2032mm	No	1		
		Supply deliver and install Store room ceiling using shutter ply boards wooden ceiling 18 to 22mm thick fixed on 156x38mm no joint beams, price must include nails, other accessories etc.				
B8.2			m <sup>2</sup>	10		
Total Carried Forward						

LIMPOPO DEPARTMENT OF AGRICULTURE AND RURAL DEVELOPMENT



**DEPARTMENT OF AGRICULTURE AND RURAL DEVELOPMENT**

**CONSTRUCTION OF CHILI PEPPER DRYING FACILITY AT ROYAL FIELDS FARM UNDER MUSINA LOCAL MUNICIPALITY IN VHEMBE DISTRICT OF LIMPOPO PROVINCE**

Item No	Payment	DESCRIPTION	UNIT	QTY	RATE	AMOUNT
<b>SECTION B: BUILDING WORKS</b>						
		brought forward				
B8.3		Manufacture, Supply & install steel frame residential windows including factory fitted burglar proofing, glazing, including all ironmongery, screws, etc. and Glazing with 4mm clear float glass to panes not exceeding 0.1m <sup>2</sup> Window type NE4	No	2		
B9		<b>PAINTWORK</b> <b>PAINTWORK ON BRICK WALL</b> <b>Apply two coats clear varnish</b>				
B9.1		On internal walls	m <sup>2</sup>	50		
B9.2		On external walls	m <sup>2</sup>	90		
B9.3		<b>ON WOOD SURFACES</b> <b>One coat primer of clear Varnish</b> On doors	m <sup>2</sup>	4		
B10		<b>Water and Drainage Sink</b>				
B10.1		Supply, deliver and install free standing stainless steel sink double bowl 1700mm.	no	1		
B10.2		Supply and deliver and install 50 mm drainage pipe to connect sink and 110 mm pipe, price must include sink trap, elbows, tee etc.	m	6		
B10.3		supply deliver and install 110 drainage pipe to exiting septic tank, price must include excavations, backfill, elbow etc.	m	50		
B11	SANS 1200H, HA, 121	<b>STEEL SHED AND ROOFING</b>				
B11.1		Supply, fabricate, surface preparation, shop priming, delivery to site & installation of 11m wide, 16m long and 3.5m high steel structure. Including all necessary purlins, columns, rafters, bracing sections, cleats, brackets, gussets, nuts, bolts, washers, etc to complete the shed as per provided drawings. Use IPE 160 for columns and rafter, purlins 100 x 75 x20x2 lipped channels, Engineering certificate must be produced if different design is used, otherwise boiler maker certificate must be produced if provided drawing is used.	sum	1		
B11.2		Painting on site of steel structure after erection with one coat universal undercoat and two coats gloss enamel applied on site after erection, including for touch-up work and preparation required before painting.	sum	1		
B12		<b>ROOF SHEETING</b>				
B12.1		Supply and fix including all fixing screws, IBR 0.55mm thick Chromadek traffic green coated on the Roof to sandwich the insulation for roof, etc. for a 11x16m building as per provided drawing.	m <sup>2</sup>	240		
B13		<b>INSULATION</b>				
B13.1		Supply and install the following Alububle roof expanded Polystyrene insulation , rate must include all straining wires, etc. spaced according to the manufacturers specifications etc.	m <sup>2</sup>	180		
Total B Carried summary						



LIMPOPO DEPARTMENT OF AGRICULTURE AND RURAL DEVELOPMENT



**LIMPOPO**  
PROVINCIAL GOVERNMENT  
REPUBLIC OF SOUTH AFRICA

**DEPARTMENT OF  
AGRICULTURE AND RURAL DEVELOPMENT**

**CONSTRUCTION OF CHILI PEPPER DRYING FACILITY AT ROYAL FIELDS FARM UNDER MUSINA LOCAL MUNICIPALITY IN VHEMBE DISTRICT OF LIMPOPO PROVINCE**

Item No	Payment	DESCRIPTION	UNIT	QTY	RATE	AMOUNT
<b>SECTION 3: EQUIPMENT</b>						
C1		<b>Carry out the following operation as applicable: Manufacture, supply, deliver, install, commission, test and attend to defects for the following items: DRYER</b>				
C1.1		Allow a provisional sum for the procurement and installation of fruit dryer equipment with 1 ton output per 16hr, 900 trays, drying area 486m <sup>2</sup> , fans 5, element 48, electrical panel equipped with isolator, circuit breakers, fan contactor, emergency stop, PLC with pre-loaded software, temperature and humidity sensor, digital timer, UPS, inlet and exhaust damper from nominated manufacturer.	Prov sum	1	1,300,000	R 1,300,000.00
C1.2		Profit on above item	%	1,300,000		
C2		<b>CUTTER</b>				
C2.1		VEG PREP Machine - (300 Servings) with Stainless steel mobile stand with container for tools with automatic stainless steel feed head, pusher feed head capacity 3 litres with integrated cylindrical hopper, adjustable cart GN1x1, two containers GN1x1 with multi cut pack 16	no	1		
C2.2		Slicer 3mm CL50/CL60/R502	no	1		
C2.3		Slicer 4mm CL50/CL60/R502	no	1		
C3		<b>COLDROOM</b>				
C3.1		<b>Carry out the following operation as applicable: Manufacture, supply, deliver, install, commission, test and attend to defects for the following items:</b>  Temperature Range: Programmable set point from +25°C to +4°C Capacity: Approximately 10m <sup>3</sup> , Dimensions Exterior (L x W x H): 6000 x 3000 x 2400 mm, Display / user interface: Push Button LED, 100mm 16 DV White Chromadek Fluted Panels (white), Access Security: Key Lock, Monitoring and sensor compatibility: Thermo Scientific Smart-Vue Compatible, Defrost: Manual, Temperature uniformity: Max variation less than 1°C. <b>Standard swing door equipped with lock &amp; key, safety latch (doors can open from inside even if locked), edge mount hinges.</b> Price must include supply and installation of condensing unit, Thermometer, compressor, Blower Coil Medium Temp. Gas, <b>Control panels</b> , digital temperature control etc. price must include issuing of COC. <b>Note: refrigeration system equipment (compressor, Condenser etc.</b>	Sum	1		
3.3.2		Supply and install 4.5 Kg DCP ( ABC Type ) Fire extinguisher	no	2		
Total C Carried summary						

LIMPOPO DEPARTMENT OF AGRICULTURE AND RURAL DEVELOPMENT



**LIMPOPO**  
PROVINCIAL GOVERNMENT  
REPUBLIC OF SOUTH AFRICA

**DEPARTMENT OF  
AGRICULTURE AND RURAL DEVELOPMENT**

**CONSTRUCTION OF CHILI PEPPER DRYING FACILITY AT ROYAL FIELDS FARM UNDER MUSINA LOCAL MUNICIPALITY IN VHEMBE DISTRICT OF LIMPOPO PROVINCE**

Item No	Payment	DESCRIPTION	UNIT	QTY	RATE	AMOUNT
<b>SECTION 4: ELECTRICAL WORKS</b>						
D1		<b>Carry out the following operation as applicable: Manufacture, supply, deliver, install, commission, test and attend to defects for the following items: ELECTIRCAL CONNECTIONS</b>				
D1.1		Allow provisional sum for connecting packing shed to newly buildt distribution kiosk complete with COC (design for electrical wiring, light fittings, switches, plugs, connection to main DB, as per engineer's instructions).	Prov sum	1	20,000	R 20,000.00
D1.2		Overheads, charges and profit on subitems above	%	20,000		
D2		<b>LIGHTING INSTALLATION</b>				
D2.1		Outdoor floodlight 50W LED	no	4		
D2.2		2x36W T5 Surface mounted Protected Light Fitting	no	4		
D3		<b>Distribution kiosk</b>				
D3.1		Supply, deliver and install a Double Door Cabinet Db`s - Surface & Weatherproof - IP65 - with provision for side isolator of - up to 250 A - 35 KA - pad lockable - 1.6mm M/Steel DINRAIL 3 X 24 DIN, price must include 160A, 100A, 60A Circuit breakers, all cable required for connection from Eskom kiosk to distributing kiosk and to dryer, size up to 35mm2 (5 m away)	Sum	1		
D3.2		Cable from Eskom metering kiosk to Districbution kiosk, and from distribution kiosk to Dryer size From to 25 mm2 to 35 mm2	m	1		
D3.3		Cable from distribution kiosk to Main DB building, size Up to 6 mm2	m	1		
D4		<b>Commissioning of dryer</b>				
D4.1		Supply, deliver and offload Chillie pepper, for commisioning of dryer and coldroom	Prov sum	1	10000	R 10,000.00
D4.2		Overheads, charges and profit on subitems above	%	10,000		
Total D Carried Forward To Summary						

BILL OF QUANTITIES:  
CONSTRUCTION OF CHILI PEPPER DRYING FACILITY AT ROYAL FIELDS FARM

LIMPOPO DEPARTMENT OF AGRICULTURE AND RURAL DEVELOPMENT



**LIMPOPO**  
PROVINCIAL GOVERNMENT  
REPUBLIC OF SOUTH AFRICA

**DEPARTMENT OF  
AGRICULTURE AND RURAL DEVELOPMENT**

CONSTRUCTION OF CHILI PEPPER DRYING FACILITY AT ROYAL FIELDS FARM UNDER MUSINA  
LOCAL MUNICIPALITY IN VHEMBE DISTRICT OF LIMPOPO PROVINCE

**BOQ SUMMARY TO FORM CONTRACT AMOUNT**

Item	Description	Amount
<b>A</b>	Preliminary and Generals	
<b>B</b>	Building Works	
<b>C</b>	Equipment	
<b>D</b>	Electrical Works	
	<b>Sub Total</b>	
	<b>Add 10% Contingencies</b>	
	<b>Sub Total</b>	
	<b>Add 15% VAT</b>	
	<b>TOTAL BID AMOUNT</b>	

Contractor Name: \_\_\_\_\_

Signature : \_\_\_\_\_

Date : \_\_\_\_\_

---

## **PART C3: SCOPE OF WORK**

### **C3.1: STANDARD SPECIFICATIONS**

### **C3.2: PROJECT SPECIFICATIONS**

### **C3.3: PARTICULAR SPECIFICATIONS**

---

## **LIMPOPO DEPARTMENT OF AGRICULTURE AND RURAL DEVELOPMENT**

### **CONSTRUCTION OF CHILI PEPPER DRYING FACILITY AT ROYAL FIELDS FARM UNDER MUSINA LOCAL MUNICIPALITY IN VHEMBE DISTRICT OF LIMPOPO PROVINCE**

#### **C3: SCOPE OF WORK**

##### **C3.1 STANDARD SPECIFICATIONS**

##### **C3.2 PROJECT SPECIFICATIONS**

###### **PART A: GENERAL**

PS-1	Project Description
PS-2	Description of the Site and Access
PS-3	Details of the Works
PS-4	Construction Programme
PS-5	Site Facilities Available
PS-6	Facilities Required on site
PS-7	Management and Disposal of Water
PS-8	Rainfall Figures
PS-9	Security Clearance of Personnel
PS-10	Health and Safety
PS-11	Subcontractors
PS-12	Deviation from Construction Programme
PS-13	Delay in Completion
PS-14	Supply of Materials
PS-15	Execution of Works
PS-16	Existing Services
PS-17	Labour Intensive Specification

###### **PART B: AMENDMENTS TO THE STANDARD SPECIFICATIONS**

##### **C3.3 PARTICULAR SPECIFICATIONS**

###### **PART C: MECHANICAL**

###### **PART D: ENVIRONMENTAL MANAGEMENT SPECIFICATION**

###### **PART E: OHSA 1993 HEALTH AND SAFETY**

## LIMPOPO DEPARTMENT OF AGRICULTURE AND RURAL DEVELOPMENT

### CONSTRUCTION OF CHILI PEPPER DRYING FACILITY AT ROYAL FIELDS FARM UNDER MUSINA LOCAL MUNICIPALITY IN VHEMBE DISTRICT OF LIMPOPO PROVINCE

#### C3.1 STANDARD SPECIFICATIONS

The standard specifications on which this contract is based are the SANS Standardised Specifications for Civil Engineering Works.

The following SANS specifications are also referred to in this document and the Contractor is advised to obtain them from Standards South Africa (a division of SABS) in Pretoria.

SABS 1200 A	-	General
SABS 1200 C	-	Site Clearance (amended 1982)
SABS 1200 DA	-	Earthworks (Small Works)
SABS 1200 GA	-	Concrete (Small Works)
SABS 1200 HA	-	Structural Steelwork
SABS 1200 HB	-	Cladding and Sheeting
SABS 1200 HC :		Corrosion Protection of Structural Steelwork

The following SANS specifications are also referred to in this document and the Contractor is advised to obtain them from Standards South Africa (a division of SABS) in Pretoria.

SANS 10049:2012 Edition 4.1: Food safety management for prerequisite programmes (PRPs)

SANS 10396: 2003: Implementing Preferential Construction Procurement Policies using Targeted Procurement Procedures

SANS 1914-1 to 6 (2002): Targeted Construction Procurement

SANS 1921 – 1 (2004): Construction and Management Requirements for Works Contracts Part 1: General Engineering and Construction Works

and where accommodation of traffic is involved:

SANS 1921-2 (2004): Construction and Management Requirements for Works Contracts Part 2: Accommodation of Traffic on Public Roads Occupied by the Contractor.

---

## **Mechanical**

The following standards shall apply, unless otherwise stated:

BS 15

SABS 222 : Dimensions and properties of rolled carbon steel structure sections (withdrawn) – see also SABS 1431 and the SA Steel Construction Handbook

SABS 763 : Hot- dip (galvanised) zinc coatings (other than on continuously zinc-coated sheet and wire)

SABS 1431 : Weldable structural steels

BS 449 PART 5

BS 916

SABS 135 : ISO metric bolts, screws and nuts (hexagon and square) (coarse thread free fit series)

BS 3382

BS 3410 PART 2

BS 3139 PART 1

The latest version of all standards shall be used.

# LIMPOPO DEPARTMENT OF AGRICULTURE AND RURAL DEVELOPMENT

## CONSTRUCTION OF CHILI PEPPER DRYING FACILITY AT ROYAL FIELDS FARM UNDER MUSINA LOCAL MUNICIPALITY IN VHEMBE DISTRICT OF LIMPOPO PROVINCE

### C3.2: PROJECT SPECIFICATIONS

#### STATUS

The Project Specification, consisting of two parts, forms an integral part of the contract and supplements the Standard Specifications.

Part A contains a general description of the works, the site and the requirements to be met.

Part B contains variations, amendments and additions to the Standardized Specifications and, if applicable, the Particular Specifications.

In the event of any discrepancy between a part or parts of the Standardized or Particular Specifications and the Project Specification, the Project Specification shall take precedence. In the event of a discrepancy between the Specifications, (including the Project Specifications) and the drawings and / or the Bill of Quantities, the discrepancy shall be resolved by the Engineer before the execution of the work under the relevant item.

The standard specifications which form part of this contract have been written to cover all phases of work normally required for road contracts, and they may therefore cover items not applicable to this particular contract.



## **PART A: GENERAL**

### **PS 1 PROJECT DESCRIPTION**

The project's infrastructure development will include the installation and establishment of chili dehydrating equipment, a chili storage facility, and chili dicing machinery. These devices will play a crucial role in the refining and preservation of chilies, allowing them to be preserved and utilized for extended periods of time. In addition, a pack-shed will be built to provide a designated area for packaging, cover for the chili-drying equipment, and storage for the processed chilies.

### **PS 2 DESCRIPTIONS OF THE SITE AND ACCESS**

#### **PS 2.1 Location of site**

Incidental intrusion into private property shall not be permitted without the owner's written authority. Any such agreement reached with a private landowner (occupier) shall include the provision that any material or equipment on that site shall remain the exclusive property of the Employer in terms of the contract.

#### **PS 2.2 Access to site**

The farm is located along the R525 road to Kruger Pafuri gate. The farm is about 130km from Musina Town. The area can also be accessed from the Baobab Tollgate, using road R525 and 130 km from the toll gate.

Site coordinates 22°27'13.05"S 30°30'7.65"E

The contractor shall be responsible for the maintenance and re-instatement of damage caused by him or his agents / deliveries during the construction activities. No damage to flora or fauna located outside the limits of the site will be permitted in this contract.

The contractor should take cognisance of the aforementioned items concerning the environment and allow for any costs in his Tender under the relevant section in the Bill of Quantities.

### **PS 3 DETAILS OF THE WORKS**

#### **PS 3.1 Brief description of works**

The brief description of the works to be carried out on this project are as discussed below:

- Access and Site clearance for sites
- Excavation and foundations
- Steel fabricated structure and roofing
- Electrical line
- Supply, deliver and install 1 ton dryer
- Cold room for 1 ton of produce

#### **PS 3.3 Labour recruitment conditions**

A Project Steering Committee (PSC) will be established and is a vital means of communication between all parties involved with the project. The composition of the PSC comprises representation by the Employer, the Engineer and formal structures within the community.

The contractor shall make use of these communication channels, and shall appoint from amongst his site personnel a responsible person to participate in the affairs of the PSC, and this representative may be also required to attend the monthly PSC meetings.

It is mandatory that the Contractor shall interact with the community via proactive project liaison and project participation by its leaders and constituted organisations and forums, as well as through the employment of its people, and these activities shall constitute essential facets of the project.

Local labour is to be used and the employment of such labour is to be done in conjunction with the PSC.

PSC shall, if necessary, appoint a Community liaison officer (CLO). The duties of the CLO shall consist inter alias of the following:

- To be available on site daily between the hour of 07:00 and 17:00 and at other times as the need arises. His normal working day will extend from 07:00 in the morning until 17:00 in the afternoon.
- To communicate daily with regard to number and skills, to facilitate in labour disputes and to assist in their resolution.
- To attend all meetings in which the community and/or labour are present or are required to be represented.
- To attend all PSC meeting to report on labour.
- To assist in the identification and screening of labourers from the community in accordance with the contractor's requirements.
- To advise and inform temporary labourers of their conditions of employment and to inform temporary labourers as early as possible when their period of employment will be terminated.
- To attend disciplinary proceedings to ensure that hearings are fair and reasonable.
- To keep a daily written record of his interviews and community liaison, labour force etc.
- To attend monthly site meetings and report in writing on labour and contract matters.
- Keeping a data base of available labour.
- All such other duties as agreed upon between all parties concerned.
- Compile a list of available skills in the area (skills audit).

## **PS 4 CONSTRUCTION PROGRAMME**

### **PS 4.1 General**

The submission of a construction programme as stated per Clause 12 of the General Conditions of Contract is compulsory.

Before any work is to be commenced on the site (within a period as stated in Clause 12.2 of the General Conditions of Contract), the Contractor must submit a detailed project programme for the construction of the Works to the Engineer for his approval.

In preparation of the construction programme the Contractor must liaise with the Engineer and the programme must take into account the coordination of all activities. The programme must consist of a detailed schedule or block diagram covering all aspects of the Works and the planned time thereof must, with the Contract Period as time basis, be shown.

Rainfall conditions will be taken as abnormal when the average rainfall, as shown in Clause PS 8, is exceeded and the contractor must then apply in writing for extension of the contract period using Clause 48 of the Conditions of Contract.

The service provider is required to state in the Appendix to the Form of Tender the time in which he is prepared to undertake and complete the works.

The Contractor shall submit to the Engineer a realistic, detailed programme not later than 14 days after receipt of the Letter of Acceptance. The programme shall be in bar-chart format showing in detail how the Contractor proposes to complete the work covered by this contract by the Due Completion Date.

The following details must be stated:

- I. The quantity of work applicable to each bar item as well as the rate at which the work will be completed.

- II. A budget of the value of completed work, month by month, for the full contract period.
- III. The Contractor's plant commitment on the contract for every fortnight.
- IV. The critical path.

The programme shall be kept up to date. If a Contractor fails to maintain progress in terms of the programme, he shall produce a revised programme showing the modifications to the original programme necessary to ensure completion of the Works before the Due Completion Date.

The approval of any programme by the Engineer shall have no contractual significance, other than satisfying the Engineer that the Work is carried out according to such programme and that the Contractor undertakes to carry out the work in accordance with the programme. The Engineer will have the right to instruct the Contractor to revise the programme if necessitated by circumstances.

#### **PS 4.2 Time for Completion**

The maximum time allowed for the completion of the contract is **5 MONTHS** (excluding special non-working days and the yearend break) from the date of Letter of Acceptance / or Site Handover.

### **PS 5 SITE FACILITIES AVAILABLE**

#### **PS 5.1 Water Supply**

The Contractor must make his own arrangements for provision of fresh water on site for domestic and construction purposes.

The rates Tendered for the relevant items in the Preliminary and General Section of the schedule shall include all costs for the establishment and maintenance of water supply to the works and the Contractor shall make his own arrangements for the possible conveyance and storage of water if necessary.

#### **PS 5.2 Power Supply**

The Contractor must make his own arrangements for the provision of electricity on site. The rates Tendered for the relevant items in the Preliminary and General Section of the schedule shall include all costs for the establishment and maintenance of a power supply to the works.

### **PS 6 FACILITIES REQUIRED ON SITE**

#### **PS 6.1 Facilities for the Engineer**

A site office for the Engineer is not required.

#### **PS 6.2 Facilities for the Contractor**

##### **Site Establishment**

The Contractor is responsible to provide a suitable site for his camp and to provide accommodation for his personnel and labourers. If the Employer can make any specific site available to the Contractor, such site will be pointed out to the Contractor. The site office should be user friendly, cleaned at all times and be equipped with office furniture such as printer, desk and chairs. As the area is hot during summer, a fan will be necessary for the site office.

The chosen site shall be subject to the approval of the beneficiary/Engineer and the Project Steering Committee (if available). Possible locations for a campsite shall be pointed out at the Site inspection. The Contractor shall conform to all beneficiary, local authority, environmental and industrial regulations.

The Contractor shall make his own arrangements concerning the supply of electrical power and all other services. No direct payment shall be made for the provision of electrical and other services. The cost thereof

---

shall be deemed to be included in the rates and amounts Tendered for the various items of work for which these services are required.

The Contractor shall provide security watchmen for the contract as he deems fit at no extra cost for the Employer. The Contractor must ensure that all his employees as well as the employees of his subcontractors are able to identify themselves as members of the construction team.

**Ablution and Sanitary Facilities:**

The Contractor shall erect and maintain on the site proper ablution facilities. The Contractor shall service and maintain the facilities in a clean and hygienic state for the duration of the contract period and on completion of the works remove it from the site to the satisfaction of the Employer/beneficiary.

**PS 6.3 Laboratory Facilities**

The contractor shall provide laboratory facilities at an SABS accredited laboratory to conduct tests as required or as specified/measured in the bills of quantity.

**PS 6.4 Construction Notice Board (Name Board)**

1 Official Name Board per site (if necessary), as per C4.2 Site Information: Construction Notice Board, is required for this contract.

**PS 6.5 Housing for the Engineer and/or his Representative**

No housing is required for the Engineer or his Representative.

**PS 6.6 Telephone Facilities**

Items have been provided in the Bill of Quantities to cover for communication costs for the Engineer.

**PS 7 MANAGEMENT AND DISPOSAL OF WATER**

The Contractor shall pay special attention to the management and disposal of water and stormwater on the site. It is essential that all completed works or parts thereof are kept dry and properly drained. Claims for delay and for repair of damage caused to the works as a result of the Contractor's failure to properly manage rain and surface water, will not be considered.

**PS 8 RAINFALL FIGURES**

The following figures are applicable for Clause 50(5) of the Special Conditions of Contract.

INFORMATION SOURCE: WRC Report 1994

<b>Rainfall station: Messina</b>					
<b>Rainfall station:</b>					
<b>Period:</b>					
<b>Month</b>	<b>N<sub>n</sub></b>	<b>R<sub>n</sub></b>	<b>Month</b>	<b>N<sub>n</sub></b>	<b>R<sub>n</sub></b>
January	11	140	July	1	5
February	13	162	August	1	8
March	7	76	September	1	23
April	4	41	October	2	37
May	2	17	November	5	100
June	1	6	December	11	128

**N<sub>n</sub>** = Average amount of days on which a rainfall of 10 mm or more has been recorded.  
**R<sub>n</sub>** = Average monthly rainfall in mm

The contractor will be expected to maintain on site a standard rain gauge for measurement of rainfall on day to day basis during the project implementation period.

Extensions of time in respect of Clause 42 in the General Conditions of Contract for Construction Works (2004) in respect of abnormal rainfall shall be calculated using the following formula for each calendar month or part thereof:

$$V = (N_w - N_n) + \frac{(R_w - R_n)}{X}$$

Where:

- V = Extension of time in calendar days in respect of the calendar month under consideration.
- N<sub>w</sub> = Actual number of days during the calendar month on which a rainfall of 10 mm or more has been recorded.
- N<sub>n</sub> = Average number of days in the relevant calendar month, as derived from existing rainfall records, on which a rainfall of 10mm or more has been recorded for the calendar month.
- R<sub>w</sub> = Actual average rainfall in mm recorded for the calendar month under consideration.
- R<sub>n</sub> = Average rainfall in mm for the calendar month as derived from existing rainfall records as stated in the Site Information.
- X = 20mm

For purposes of the Contract N<sub>n</sub>, R<sub>n</sub> and N<sub>n</sub> shall have those values assigned to them in the table above based on figures from the WRC report 1994.

If V is negative and its absolute value exceeds N<sub>n</sub>, then V shall be taken as equal to minus N<sub>n</sub>.

The total extension of time shall be the algebraic sum of all monthly totals for the period under consideration, but if the total is negative the time for completion shall not be reduced due to subnormal rainfall. Extensions of time for part of a month shall be calculated using pro rata values of N<sub>n</sub> and R<sub>n</sub>.

This formula does not take account flood damage which could cause further or concurrent delays and will be treated separately as far as extension of time is concerned.

The factor (N<sub>w</sub> – N<sub>n</sub>) shall be considered to represent a fair allowance for variations from the average in the number of days during which rainfall exceeds 10 mm. The factor (R<sub>w</sub>-R<sub>n</sub>) shall be considered to represent a

fair allowance for variations from the average in the number of days during which the rainfall did not exceed 10 mm but wet conditions prevented or disrupted work.

For the purpose of applying the formula, accurate rain gauging shall be taken at a suitable point on the Site and the Contractor shall at his own expense, take all necessary precautions to ensure that rain gauges cannot be interfered with by unauthorized persons.

## **PS 9 SECURITY CLEARANCE OF PERSONNEL**

Service Providers to note that the Limpopo Department of Agriculture may require that Security Clearance investigations be conducted on any number of the service providers personnel.

If so required, by the Limpopo Department of Agriculture, the service provider must remove personnel as indicated immediately and ensure that they have no access to the works or documentation or any other information pertaining the site.

The Employer shall not be liable for any cost concerning the removal of personnel or the effect thereof on the execution of the work.

## **PS 10 HEALTH AND SAFETY**

### **PS 10.1 General statement**

It is a requirement of this contract that the Contractor shall provide a safe and healthy working environment and to direct all his activities in such a manner that his employees and any other persons, who may be directly affected by his activities, are not exposed to hazards to their health and safety. To this end the Contractor shall assume full responsibility to conform to all the provisions of the Occupational Health and Safety Act (OHSA) No 85 and Amendment Act No 181 of 1993, and the OHSA 1993 Construction Regulations 2003 issued on 18 July 2003 by the Department of Labour.

For the purpose of this contract the Contractor is required to confirm his status as mandatory and employer in his own right for the execution of the contract by entering into an agreement with the Employer in terms of the Occupational Health and Safety Act in the form as included in section C1.5.

### **PS 10.2 Health and Safety Specifications and Plans**

#### **(a) Employer's Health and Safety Specification**

The Employer's Health and Safety Specification is included in Section C3.3, Part E of the Tender documents as part of the Particular Specifications.

#### **(b) Service Providers Health and Safety Plan**

The service provider shall submit with the Tender his own documented Health and Safety Plan he proposes to be implement for the execution of the work under the contract. The Health and Safety Plan must at least cover the following:

- (i) a proper risk assessment of the works, risk items, work methods and procedures in terms of Regulations 7 to 28;
- (ii) pro-active identification of potential hazards and unsafe working conditions;
- (iii) provision of a safe working environment and equipment;
- (iv) statements of methods to ensure the health and safety of subcontractors, employees and visitors to the site, including safety training in hazards and risk areas (*Regulation 5*);
- (v) monitoring health and safety on the site of works on a regular basis, and keeping of records and registers as provided for in the Construction Regulations;
- (vi) details of the Construction Supervisor, the Construction Safety Officers and other competent persons he intends to appoint for the construction works in terms of Regulation 6 and other applicable regulations; and

- (vii) details of methods to ensure that his Health and Safety Plan is carried out effectively in accordance with the Construction Regulations 2003.

The Contractor's Health and Safety Plan will be subject to approval by the Employer, or amendment if necessary, before commencement of construction work. The Contractor will not be allowed to commence work, or his work will be suspended if he had already commenced work, before he has obtained the Employer's written approval of his Health and Safety Plan.

Time lost due to delayed commencement or suspension of the work as a result of the Contractor's failure to obtain approval for his safety plan, shall not be used as a reason to claim for extension of time or standing time and related costs

### PS 10.3 Cost of compliance with the OHS Act Construction Regulations

The rates and prices Tendered by the Contractor shall be deemed to include all costs for conforming to the requirements of the Act, the Construction Regulations and the Employer's Health and Safety Specification as applicable to this contract.

Should the Contractor fail to comply with the provisions of the Construction Regulations, he will be liable for penalties as provided in the Construction Regulations and in the Employer's Health and Safety Specification.

### **PS 11 SUB-CONTRACTORS**

The Contractor shall have the right to cede any sub-contract under this contract to a subcontractor of his/her choice.

### **PS 12 DEVIATION FROM CONSTRUCTION PROGRAMME**

The programme of work as required in terms of the "General Conditions of Contract 2nd edition (2010)" shall be submitted to the Engineer not later than fourteen days after the Commencement Date.

The Contractor shall take into account the requirements of the Occupational Health and Safety Act, as well as the Construction Regulations in the drafting of the programme.

The format shall not be in the form of a bar chart only, but shall also clearly indicate the anticipated quantity of work to be executed each month. The construction programme shall also clearly indicate the local and foreign labour to be utilised for the duration of the Contract.

If during the progress of the work, the quantities of the work performed per month fall below the expected indicated in the Construction programme, or if the sequence of operation is altered, or if the programme is deviated from in any other way, the Contractor shall, within one week after being notified by the Engineer, submit a revised construction programme.

Such a revised construction programme shall be based on the tempo of work achieved by the Contractor up to the date of revision. Any proposal to increase the tempo of work must be accompanied by positive steps to increase production by providing more labour and plant on site or by using the available labour and plant in a more efficient manner.

Failure on the part of the Contractor to work according to the programme or revised programmes shall be sufficient reason for the Engineer to take steps as provided for in the "General Conditions of Contract – 2nd edition (2010)"

### **PS 13 DELAY IN COMPLETION**

The Contractor shall organise the Works in such a manner that no delays occur. Delay due to faulty organisation or lack or shortage of materials or labour or co-operation with other parties or to any other cause within the control of the Contractor will not be countenanced and full power is reserved by the Engineer to order the Contractor to expedite the work should the work, in the opinion of the Engineer, not progress in a satisfactory way

## **PS 14 SUPPLY OF MATERIALS**

All material to be used in the Works is to be supplied by the Contractor.

The Contractor shall ensure that the work is not delayed due to the lack of materials on Site, by placing orders for material required under this Contract as soon as possible. No extension of time will be allowed for any delay due to the supply of materials.

Although the quantities have been carefully calculated, it must be considered as approximate only and the Contractor, before ordering any materials, should check the quantities required. The bill of quantities is provisional.

## **PS 15 EXECUTION OF THE WORKS**

### **PS 15.1 Inspection by the Engineer**

No portion of the work shall be proceeded with until the Engineer or his representative has examined and approved the previous stage. If any work is covered or hidden from view before the Engineer or his representative has inspected the work, the Contractor shall at his own cost expose the covered or hidden work for inspection. The Contractor shall also be responsible for making good any work damaged during the uncovering.

### **PS 15.2 Certificate of Completion**

When all the work under the Contract have been completed to the entire satisfaction of the Engineer, he will issue a certificate of completion to the Contractor informing the Contractor of the date the date at which the works are deemed to be completed and accepted by the Employer.

The sureties provided by the Contractor for the fulfilment and completion of the Contract in terms of the Form of Agreement will be released upon the issue of the Certificate of Completion.

## **PS 16 EXISTING SERVICES**

The Contractor shall make himself acquainted with the position of all existing services before any excavation or other work likely to affect the existing services is commenced.

The Contractor will be held responsible for any damage to known existing services caused by or arising out of his operations and any damage shall be made good at his own expense. Damage to unknown services shall be repaired as soon as possible and liability shall be determined on site when such damage should occur.

A provisional amount is included in the bill of quantities for the protection and/or shifting of services.

Two weeks prior to commencing construction activities in a particular area, the Contractor shall also diligently enquire of local landowners as to whether there are any other known services which have not been shown on the drawings but which may be affected by the construction activities in that area, and any such services shall be brought to the attention of the Engineer immediately. The contractor shall make provision in his programme for the location and/or shifting of services.

The Contractor shall take note of the requirements of the standard specifications with regard to services.

## **PS 17 LABOUR INTENSIVE SPECIFICATION**

### **PS 17.1 Labour intensive competencies of supervisory and management staff**

Contractors having a CIDB contractor grading designation of 2CE and higher shall only engage supervisory and management staff in labour intensive works who have either completed, or for the period 1 April 2004 to 30 June 2006, are registered for training towards, the skills programme outlined in Table 1.



The managing principal of the contractor, namely, a sole proprietor, the senior partner, the managing director or managing member of a close corporation, as relevant, having a contractor grading designation of 1CE and 2CE, shall have personally completed, or for the period 1 April 2004 to 30 June 2006 be registered on a skills programme for the NQF level 2. All other site supervisory staff in the employ of such contractors must have completed, or for the period 1 April 2004 to 30 June 2006 be registered on a skills programme for, the NQF level 2 unit standards or NQF level 4 unit standards.

**Table 1: Skills programme for supervisory and management staff**

Personnel	NQF level	Unit standard titles	Skills programme description
Team leader / supervisor	2	Apply Labour Intensive Construction Systems and Techniques to Work Activities	This unit standard must be completed, <b>and</b>  any one of these 3 unit standards
		Use Labour Intensive Construction Methods to Construct and Maintain Roads and Stormwater Drainage	
		Use Labour Intensive Construction Methods to Construct and Maintain Water and Sanitation Services	
		Use Labour Intensive Construction Methods to Construct, Repair and Maintain Structures	
Foreman/ supervisor	4	Implement labour Intensive Construction Systems and Techniques	This unit standard must be completed, <b>and</b>  any one of these 3 unit standards
		Use Labour Intensive Construction Methods to Construct and Maintain Roads and Stormwater Drainage	
		Use Labour Intensive Construction Methods to Construct and Maintain Water and Sanitation Services	
		Use Labour Intensive Construction Methods to Construct, Repair and Maintain Structures	
Site Agent / Manager (i.e. the contractor's most senior representative that is resident on the site)	5	Manage Labour Intensive Construction Processes	Skills Programme against this single unit standard

**PS 17.2 Employment of unskilled and semi-skilled workers in labour-intensive works**

**PS 17.2.1 Requirements for the sourcing and engagement of labour.**

Unskilled and semi-skilled labour required for the execution of all labour intensive works shall be engaged strictly in accordance with prevailing legislation and SANS 1914-5, Participation of Targeted Labour.

The rate of pay set for a day task is 90% of the statutory daily wage applicable for the areas.

Tasks established by the contractor must be such that:

- a) the average worker completes 5 tasks per week in 40 hours or less; and
- b) the weakest worker completes 5 tasks per week in 55 hours or less.

The contractor must revise the time taken to complete a task whenever it is established that the time taken to complete a weekly task is not within the requirements of 5.2.1.3.

The Contractor shall, through all available community structures, inform the local community of the labour intensive works and the employment opportunities presented thereby. Preference must be given to people with previous practical experience in construction and / or who come from households:

- a) where the head of the household has less than a primary school education;
- b) that has less than one full time person earning an income;
- c) where subsistence agriculture is the source of income.
- d) those who are not in receipt of any social security pension income

The Contractor shall endeavour to ensure that the expenditure on the employment of temporary workers is in the following proportions:

- a) 60 % women;
- b) 20% youth who are between the ages of 18 and 25; and
- c) 2% on persons with disabilities.

#### **PS 17.2.2 Specific provisions pertaining to SANS 1914-5**

##### **Training of targeted labour**

- a) The contractor shall provide all the necessary on-the-job training to targeted labour to enable such labour to master the basic work techniques required to undertake the work in accordance with the requirements of the contract in a manner that does not compromise worker health and safety.
- b) The cost of the formal training of targeted labour will be funded by the provincial office of the Department of Labour. This training should take place as close to the project site as practically possible. The contractor, must access this training by informing the relevant provincial office of the Department of Labour in writing, within 14 days of being awarded the contract, of the likely number of persons that will undergo training and when such training is required. The employer must be furnished with a copy of this request.
- c) The contractor shall be responsible for scheduling the training of workers and shall take all reasonable steps to ensure that each beneficiary is provided with a minimum of six (6) days of formal training if he/she is employed for 3 months or less and a minimum of ten (10) days if he she is employed for 4 months or more.
- d) The contractor shall do nothing to dissuade targeted labour from participating in training programmes.
- e) An allowance equal to 100% of the task rate or daily rate shall be paid by the contractor to workers who attend formal training, in terms of d above.
- f) Proof of compliance with the requirements of b to e must be provided by the Contractor to the Employer prior to submission of the final payment certificate.

## **PART B: AMENDMENTS TO THE STANDARD SPECIFICATIONS**

### **B1 PROJECT SPECIFICATIONS RELATING TO THE STANDARD SPECIFICATIONS AND OTHER ADDITIONAL SPECIFICATIONS**

In certain clauses in the standard, standardised and particular specifications, allowance is made for a choice to be specified in the project specifications between alternative materials or methods of construction, and for additional requirements to be specified to suit a particular contract. Details of such alternative or additional requirements applicable to this contract are contained in this part of the project specifications. It also contains the necessary additional specifications required for this particular contract.

#### **VARIATIONS TO REQUIREMENTS OF SPECIFICATIONS LISTED IN C3.1**

##### **PSAA SABS 1200 A : GENERAL (SMALL WORKS)**

##### **PSA 4.2: Contractor's Camp**

No housing is available for the Contractor's employees and the Contractor shall make his own arrangements to house his employees and transport them to site.

PSA 6.2 Degree of Accuracy

A Degree of Accuracy II shall be applicable for the construction of the various portions of the Works.

**PSC** **SABC 1200 C: SITE CLEARANCE**

PSC 3.1 Disposal of Material

Disposal areas are not available on site. The Contractor shall locate his own disposal areas and shall remove and cart away any accumulation of material generated by his construction activities and not required for further use in the Works. The cost of loading, carting away and disposing of material shall be deemed to have been included in the excavation rates.

Care should be taken during clearing that no significant amounts of topsoil are being removed and pushed into windrows. Should that be found, contractor will move such topsoil back at his own cost.

**PSDA:** **SABS 1200 DA: EARTHWORKS (SMALL WORKS)**

PSD 3 Classification for Excavation Purposes

Delete Sub-Clause 3.1 and substitute the following:

Excavation shall mean excavating in all kinds of material met with the exception only of "Rock" as hereinafter defined, and shall include for the grubbing up and clearing away of all old foundations, footings, manholes, drains, paving, etc, that may be encountered; and not claim by the Contractor in respect of such items will be allowed unless specified in the Schedules of Quantities.

PSD 3.1.3 Rock

"Rock" shall mean hard un-decomposed boulders exceeding one cubic meter each in volume and such hard stone occurring in bulk, banks or ledges, that practical excavation would require the use of explosives or drilling, wedging and splitting. Explosives may only be used if written permission has been obtained from the Engineer and there is no guarantee given or implied that this permission will be given.

Should the Contractor consider that any excavations encountered are in "rock" he shall immediately notify the Engineer in writing. Failing such notification the excavations will be assumed to be in accordance with Clause PSD3 and will be measured and paid for accordingly.

The Engineer shall be the sole judge as to the classification of materials encountered in the excavations.

**PSDB:** **SABS 1200 DB: EARTHWORKS (PIPE TRENCHES)**

PSDB 3 Classes of Excavation

Refer to Clauses PSD 3 and PSD 3.1.3 for excavation classification.

PSDB 5.6 Backfilling

In areas subject to road traffic loads and under structures, etc., backfill materials shall have a plasticity index not exceeding 12, a minimum grading modulus of 0,5 and a minimum CBR of 15 % at 93 % of Modified AASHTO maximum density (100 % Modified AASHTO maximum density for sands) if placed in the upper 150 mm of the sub-grade portion of the backfill and of 7 % if placed in the lower portion.

PSDB 5.7 Compaction

The moisture content during compaction shall be the optimum moisture content for the construction plant employed.

In unrestricted areas, the excavation shall be backfilled in layers not exceeding 150 mm compacted thickness up to 750 mm above the outer crown of the pipe and in layers not exceeding 300 mm in compacted thickness thereafter and the material shall be compacted to not less than 90 % of Modified AASHTO maximum density.

In areas subject to road traffic loads and under the structures excavations shall be backfilled in layers not exceeding 150 mm in compacted thickness, and the material shall be compacted to not less than 93 % of Modified AASHTO maximum density or 100 % in the case of non-plastic sand.

**PSGA: SABS 1200 GA: CONCRETE (SMALL WORKS)**

PSGA 5.1.2: Welding

Welding of reinforcement and steel pipes is permitted.

PSGA 5.4.1.6 Ready mixed concrete

Use of ready-mixed concrete is permitted and the manufacturer's quality control system will be acceptable.

PSGA 5.4.7 Concrete Curing

Where suitable water for curing of the concrete is not readily available, the contractor is to allow for the use of an approved curing compound.

**PSH SABS 1200 H: STRUCTURAL STEELWORKS**

PSH 3.1 Materials: Structural Steel

The various grades of steel to be used in the works are shown on the drawings.

PSH 5.1.2 Drawings and Shop Details

The Contractor shall be responsible to prepare shop drawings which will be issued to the Engineer for approval.

**PSHA SABS 1200 HA: STRUCTURAL STEELWORKS (SUNDRY ITEMS)**

None

**PSHC SABS 1200 HC: CORROSION PROTECTION OF STRUCTURAL STEELWORK**

All structural steel, excluding purlins and girts shall receive the coating system specified below. All purlins and girts shall be hot dipped galvanised.

PSHC 5.4.3.1 Abrasive Blast Cleaning

Blast cleaning of steelwork shall be to SA2 minimum standard (commercial blast).

PSHC 5.7 Coating System

The following coating system shall be applied by brush, roller or airless spray:

Primer: One Coat "Sigmacover ST", dry films thickness 75 microns.

First Coat: One coat "Sigmacover ST", dry film thickness 75 microns.

Finishing Coat: One coat "Sigmadur HS semigloss" dry film thickness 75 microns

**PSL SABS 1200 L : MEDIUM PRESSURE PIPELINES**

PSL 7.3 Testing

Confirm that the Contractor will be required to carry out the standard hydraulic pipe test with suitable testing equipment on all the pipelines.

**PSLB SABS 1200 LB: BEDDING (PIPES)**

PSLB 3 Materials

Materials for bedding shall be Class C to SABS 0102, free of organic materials and shall comprise "selected fill for bedding" or "fine granular" material.

"Selected fill for bedding" means a soil of granular nature with a PI less than 6 and shall not contain more than 10 % by dry mass of stones larger than the pipe wall thickness and shall be free of roots, vegetation and stones and lumps larger than 75 mm average dimension.

"Fine granular" means the same material except that at least 90 % by mass shall pass through a sieve having 4,5 mm square openings or a clean coarse sand as directed and not more than 10 % shall pass the 0,150 mm sieve.

PSLB 3.4.2 Selective Excavation

It is expected that the selected granular material for the bedding, cradle and blanket are generally to be derived from the trench excavation, even if to be transported along the pipeline route. It is therefore important for the contractor to be selective during trench excavation, to ensure that suitable materials are not contaminated by unsuitable materials.

In addition, topsoil is to be stockpiled separately for later use in top soiling the trench route.

---

## **C3.3 PARTICULAR SPECIFICATIONS**

**PART C: Mechanical and Electrical**

**PART D: Environmental Management**

**PART E: OHSA 1993 Health & Safety**

---

## **LIMPOPO DEPARTMENT OF AGRICULTURE AND RURAL DEVELOPMENT**

### **CONSTRUCTION OF CHILI PEPPER DRYING FACILITY AT ROYAL FIELDS FARM UNDER MUSINA LOCAL MUNICIPALITY IN VHEMBE DISTRICT OF LIMPOPO PROVINCE**

#### **C3.3 PARTICULAR SPECIFICATIONS**

In addition to the Standardised and Project Specifications the following Particular Specifications shall apply to this contract and are bound in hereafter.

**PART C: Mechanical and Electrical**

**PART D: Environmental Management**

**PART E: OHSA 1993 Health & Safety**

---

## **C5. OPERATION AND MAINTENANCE MANUALS**

The contractor prior to commissioning shall provide three copies of the Operation and Maintenance Manual. These manuals shall be of a standard acceptable to the Engineer and shall be subject to his approval. At least one set of manuals shall contain original copies.

Manuals shall be in English, shall be easy to use, practically and neatly presented, bound between plastic protected covers, clearly titled, well indexed and sectionalised and specifically applicable to the equipment supplied. Where standard manuals are used these shall be marked up to be unambiguously applicable to the equipment supplied. Drawings shall be held in plastic envelopes in the manual.

The manuals must contain the following:

- a) A description of the equipment supplied giving full details of name, manufacturer, model number, size design duty and design and performance data. This shall, inter alia, include the information called for in the Pump and Motor Data Forms – part of the bill of quantities.
- b) Descriptive and technical literature including clear and comprehensive performance curves specifically applicable to the equipment supplied. (Re Pump curves and test certificates)
- c) Operating instructions supported by drawings, flow diagrams, explanatory sketches etc as may be necessary and including details of control and protection systems incorporated, and safety precautions which must be observed.
- d) Dimensional arrangement and layout drawings.
- e) A comprehensive lubricating schedule covering all equipment supplied with full details of recommended lubricants, initial fill lubricants used, capacities and lubrication periods.
- f) A comprehensive schedule of routine maintenance with timelines, for all equipment supplied.
- g) Assembly and disassembly instructions, supported by clear assembly and/or exploded view drawings.
- h) A comprehensive spare list for the equipment, complete referenced cross sectional drawings and indicating recommended spares. All information required for the ordering of spares to be given including manufacturer's part numbers, supplier's name and all identification information.
- i) Electrical circuit drawings.
- j) Copies of all Test Certificates.
- k) Documents, information and charts providing a full record of the results of the Tests on Completion.

## **C6. INSPECTION AND TESTING**

### **C6.1 GENERAL**

- a) The equipment supplied under this Contract shall be subject to inspection by the Engineer or his Nominated Agent at all stages of manufacture.
- b) The tests and commissioning procedure laid down below and such additional tests as the Engineer may reasonably require to prove compliance with the Specification shall be carried out at the



---

Contractor's Works and at Site.

- c) The Contractor shall give reasonable notice of time and place in writing to enable the Engineer to inspect and witness tests of materials and equipment. He shall provide the Engineer with facilities for witnessing these tests and for any additional tests or inspection of any portion of the Works as required by the Engineer.
- d) The Contractor shall at his own cost render all assistance and supply all labour appliance and any other materials as the Engineer may require to check the setting out, measure up and inspect any portions of the Works at any stage during fabrication, construction, erection or painting. During such operations the Contractor shall if required suspend any or all of the Works without having claim for loss or damage as a result thereof.
- e) The testing of the plant (or a part thereof) supplied under this Contract shall be carried out through its full operating range (or part thereof) as required by the Engineer. All such tests and inspections and the necessary inspection facilities shall be provided at the Contractor's expense.
- f) At the commencement of and during the whole of Commissioning and Testing Periods, the Contractor shall have available on site all essential spares and tools considered necessary to enable repair work of defective parts to be carried out immediately in the event of a breakdown.
- g) The Contractor shall be responsible for the proper operation and maintenance of the plant throughout the period of the tests.
- h) Acceptance by the Engineer of any plant item, following such inspection or tests, shall not relieve the Contractor of any obligations under this Contract.

**C6.2 TESTING BEFORE DELIVERY**

- a) All items of plant are subject to inspection at the manufacturer's works before despatch.
- b) Materials, components and electric motors shall be tested for compliance with relevant British or South African standards and certificates submitted in triplicate.

**C6.3 TESTING AT SITE**

- a) Welds

Welds shall be tested as required by the relevant Code of Practice.

Where the test pressure specified for individual items of equipment is less than the test pressure specified for the connecting pipe line the equipment shall be disconnected for the test and suitable make-up lengths of pipe work or plugged connections shall be installed to enable the pipe line tests to be carried out.

- b) Draining and cleaning

Upon completion of the pressure test on a section of pipe work the water used for testing shall be drained away as quickly as possible to remove as much dirt and dross. After completion of a pipe work circuit the circuit shall be flushed through to remove all pipe scale, dross and similar material.

The Contractor shall provide all necessary connections, by-pass pipes, temporary strainers, temporary make-up pieces, to enable the systems to be drained and cleaned.

d. Alignment

Alignment checks of all driven machinery are required and shall be witnessed by the Engineer and the results recorded.

e. Controls

All automatic control functions, alarm and safety cut-out devices shall be tested by operational or simulated tests and set-points and calibrations set and their settings recorded, all in the presence of the Engineer.

f. Performance Tests

Tests shall be carried out on all plant items to check that they are capable of their rated performance.

Each test shall be witnessed by the Engineer and a signed certificate of approval shall be issued by the Engineer upon completion of the tests to his satisfaction.

#### **C6.4 TESTS ON COMPLETION**

During completion of the balancing and commissioning of equipment the plant shall be brought into normal operation and the final adjustments of the equipment shall be made.

Thereafter the Tests on Completion in terms of the Conditions of Contract shall be carried out to ensure that the plant will fulfil the functions for which it has been designed.

Such tests shall include the following:

- a) Simulated tests for all alarm and safety cut out equipment to prove the operation of the equipment.
- b) Simulation tests on automatic controls to prove the ability of the controls to correct the conditions outside the required design parameters needs to be done by the Contractor. The tests shall be carried out by manually changing the desired values to produce an incorrect condition and then re-setting the controls to the design conditions and checking the operation of valves, etc, to restore the design conditions.

The Contractor shall provide all necessary temporary measuring and recording equipment. The equipment shall be of a type generally used for this type of testing and shall be to the approval of the Engineer. All instruments shall be accurately calibrated before the tests begin.

On completion of the whole of the tests and when the Contractor is satisfied that the entire plant is operating satisfactorily and will fulfil the function for which it has been supplied, he shall submit to the Engineer triplicate copies of all test records and charts together with reports on all the tests called for in this Specification.

The Engineer shall reserve the right to ask for any reasonable additional tests or for the repetition of previous tests in order to prove that the operation of the plant is satisfactory and in accordance with the Specification and Drawings.

#### **C6.5 TEST CERTIFICATES**

The Contractor shall provide three copies of test certificates for the installed pumps and materials and equipment specified for testing. Further copies are to be bound into the manuals to be supplied.

---

## **PART D : ENVIRONMENTAL MANAGEMENT SPECIFICATION**

### **D.1 General**

In order to ensure that the construction works is carried out in an environmentally sensitive matter, strict compliance to the Environmental Management Plan (EMP) guidelines is required. The purpose of the EMP is to:

- Encourage good management practices through planning and commitment to environmental issues,
- Provide rational and practical environmental guidelines to:
  - i. Minimise disturbance of the natural environment,
  - ii. Prevent pollution of land, air and water,
  - iii. Prevent soil erosion and facilitate re-vegetation.
- Adopt the best practicable means available to prevent or minimise adverse environmental impact,
- Develop waste management practices based on prevention, minimisation, recycling, treatment or disposal of wastes,
- Train employees and contractors with regard to environmental obligations.

### **D.2 Training and Induction of Employees**

- The Contractor has a responsibility to ensure that all those people involved in the project are aware of and familiar with the environmental requirements for the project (this includes sub-contractors, casual labour, etc.). The EMP shall be part of the terms of reference for all contractors, sub-contractors and suppliers.

### **D.3 Complaints Register and Environmental Incident Book**

Any complaints received by the project team from the public will be recorded. The complaint should be brought to the attention of the site manager, who will respond.

The following information must be recorded:

- Time, date and nature of the complaint,
- Type of communication (telephone, letter etc),
- Name, contact address and telephone number of the complainant,
- Response and investigation undertaken and
- Actions taken and by whom.

All complaints received will be investigated and a response give to the complainant within 14 days.

All environmental incidents occurring on the site will be recorded. The following information will be provided:

- Time, date, location and nature of the incident,
- Actions taken and by whom.

### **D.4 Site Cleanliness and Neatness**

- Location of a construction camp is to be approved by the Engineer and is to be restored to its previous condition after completion of construction.
- The construction camp should preferably be fenced with a 1.8m bonnox fence or similar approved.
- All materials, equipment, plant and vehicles must be stored within the construction camp.
- A dedicated area must be made available for construction staff to change and store their personal belongings.

---

**D.5 Access**

- Access to existing roads, schools, buildings, shop and residential properties must not be impeded during construction.
- Access roads utilised by the Contractor must be maintained in good condition.

**D.6 Borrow Pits**

- Mining authorisations (permits) for borrow pits must be obtained from the Department of Minerals and Energy (DME) in consultation with the Department of Water Affairs and Forestry (DWAF).
- Spoil dumps resulting from borrow pits must not interfere with any natural surface drainage.
- Borrow pits must be rehabilitated after use in accordance with the requirements of DME and DWAF.

**D.7 Dust Control / Air Quality**

- Dust suppression measures must be implemented during construction by ensuring that all surfaces prone to dust generation are kept damp (e.g. use of water tanker).
- Ensure that vehicles and equipment are in good working conditions and that emissions are not excessive.
- Ensure that vehicles and equipment are in good working conditions and that emissions are not excessive.
- Special care must be taken in areas where the route passes close to schools and residential areas.
- The speed of construction vehicles must be reduced.

**D.8 Fauna**

- Contractor staff may not chase, catch or kill animals encountered during construction.

**D.9 Fire Prevention and Control**

- Smoking is prohibited in the vicinity of flammable substances.
- The contractor must ensure that fire-fighting equipment is available on site, particularly where flammable substances are being stored or used, and that construction staff are aware of where it is kept and how it is operated.
- Fires started for comfort (warmth) are prohibited, due to the risk of veld fires and risk to adjacent property owner's lands.

**D.10 Grave sites**

- Gravesites in close proximity to the road must not be disturbed during construction.

**D.11 Materials Handling and Spills Management**

- Any hazardous materials to be used during construction (e.g. lime, fuel, paint, etc) are to be stored in a designated area at the campsite.
- The storage containers/facilities (including any diesel/petrol tanks) must be placed on an impermeable surface and surrounded by a bund wall, in order to ensure that accidental spillage does not pollute the environment.
- Workers must at all times be made aware of the health and safety risks associated with any hazardous substances used (e.g. smoking near fuel tanks), and must be provided with appropriate protective clothing/equipment in case of spillages or accidents.
- Ensure all staff and contractors undergo relevant training in the maintenance of equipment to prevent the accidental discharge or spill of fuel, oil, lubricants and other chemicals.
- Any spill of potentially hazardous materials must be cleaned up immediately (Potentially hazardous materials on site include paint, oil, grease, fuel, turpentine, etc).
- The area of contaminated soil or spill must be deposited into the hazardous waste

---

container(s).

- The contractor should keep Peat Sorb or a similar absorbent on site to clean up any spills.
- The absorbent must be stored in a designated area and be available for inspection.
- All spills are to be recorded in the environmental incident book.

#### **D.12 Noise**

- Noise generating activities must be restricted to between 07h00 and 17h00 Monday to Friday, unless otherwise approved by the appropriate competent person in consultation with adjacent landowners/affected persons.
- All equipment, vehicles and machinery must be in good working conditions and be equipped with sound mufflers if necessary.
- Construction staff must be trained and made aware of not creating unnecessary noise such as hooting and shouting.

#### **D.13 Pollution Control**

- Soil and water pollution through usage of fuel, oil, paint, bitumen or other hazardous substances must be avoided.
- All construction vehicles are to be maintained in good working order so as to prevent soil or water pollution from oil, fuel or other leaks, and to reduce noise pollution.

#### **D.14 Rivers and Streams**

- During construction of bridge structures, there must be no obstruction of the water flow of rivers and streams.
- Excavated material must not be stockpiled on or near riverbanks, in order to prevent sedimentation occurring.
- Erosion control measures must be employed both during and after construction.
- No impediments to natural surface water flow, other than approved erosion control measures, must occur.

#### **D.15 Safety**

- Safety measures, such as detour signs, must be implemented during construction to ensure the safety of workers, pedestrians and drivers/passengers in vehicles in the vicinity of construction work.
- Special care must be taken in the vicinity of schools to ensure the safety of children wishing to cross the road under construction.
- The relevant signage (e.g. speed control signs) must be erected alongside the road during the operation phase in order to control traffic.
- Accommodation must be made for pedestrian pathways alongside the road during the construction and operation phases.

#### **D.16 Soil Management**

- Storm water drainage pipes must be installed alongside the road in all areas susceptible to soil erosion.
- Erosion should be minimised by the construction of meadow drains and the planting of indigenous vegetation on the side slopes and drains to reduce flow velocity of stormwater.
- Spoil from cuts may be used in existing erosion galleys.
- Stone pitching and gabions should be constructed at pipe culvert outlets.
- Accidental spills of contaminants onto the ground e.g. oil, concrete, fuel and chemicals should be removed together with the contaminated soil.
- If necessary an absorbent such as Peat Sorb should be used the aid in cleaning up the spill. The contaminated soil should be disposed of in an appropriate container, depending on its classification.
- Servicing and re-fuelling of vehicles must only be carried out at construction camp.

## **D.17 Worker Conduct**

Code of Conduct for Construction Personnel:

- Do not leave the construction site untidy and strewn with rubbish which will attract animal pests.
- Do not set fires.
- Do not cause any unnecessary, disturbing noise at the construction camp/site or at any designated worker collection/drop off points.
- Do not drive a construction-related vehicle under the influence of alcohol.
- Do not exceed the national speed limits on public roads or exceed the recommended speed limits on the site.
- Do not drive a vehicle which is generating excessive noise or gaseous pollution (noisy vehicles must be reported and repaired as soon as possible).
- Do not litter along the roadsides, including both the public and private roads.
- Do not pollute any water bodies (whether flowing or not).
- No member of the construction team is allowed to enter the areas outside the construction site.

## **D.18 Traffic Disturbances and Diversions**

- Any traffic diversions must be undertaken with the approval of all relevant authorities and in accordance with all relevant legislation.
- Wherever possible, traffic diversion must only take place on existing disturbed areas and remain within the existing road reserve.
- Traffic diversion routes must be rehabilitated after use.

## **D.19 Vegetation**

- Only vegetation falling directly on the route must be removed where necessary.
- Alien vegetation within the road reserve must be eradicated, and management measures must be implemented for future control of these species.
- Vegetation that has been removed from large areas (e.g. on traffic diversion routes) during construction must be replaced with indigenous vegetation after construction has been completed.

## **D.20 Waste Management**

- All general, non-hazardous waste must be placed in a skip container and disposed of at a registered waste disposal site.
- The container is to ensure that the portable toilet facilities at the campsite are properly maintained and in working order.
- No disposal, or leakage, of sewage must occur on or near the site.
- All hazardous waste (e.g. oil, plant empty lime bags, contaminated wash water, etc) must be stored in leakproof containers and disposed of a registered hazardous waste disposal site.
- The contents of waste storage containers must, under no circumstances, be emptied to the surrounding area. In general, littering, discarding or burying of any materials is not allowed on site or along the route.
- Adequate waste receptacles must be available at strategic points around the construction camp and site for all domestic refuse and to minimise the occurrence of littering.
- Concrete rubble must be collected and disposed of as directed by the Project Manager.
- Each working area must be cleared of litter and building waste (e.g. rubble, wood, concrete packets etc) on completion of the day's work.
- Any spill around the container(s) should be treated as per Section C11 and C16.

---

## PART E: OHS 1993 HEALTH AND SAFETY SPECIFICATION

### E1 SCOPE

This specification covers the health and safety requirements to be met by the Contractor to ensure a continued safe and healthy environment for all workers, employees and subcontractors under his control and for all other persons entering the site of works.

This specification shall be read with the Occupational Health and Safety Act (Act No 85 and amendment Act No 181) 1993, and the corresponding Construction Regulations 2003, and all other safety codes and specifications referred to in the said Construction Regulations.

In terms of the OHS Agreement in Section C1.2.4 of the Contract document, the status of the Contractor as mandatory to the Employer (client) is that of an employer in his own right, responsible to comply with all provisions of OHS 1993 and the Construction Regulations 2003.

This safety specification and the Contractor's own Safety Plan as well as the Construction Regulations 2003, shall be displayed on site or made available for inspection by all workers, employees, inspectors and any other persons entering the site of works.

The following are possible risks associated with this project:

- Working with electrically powered equipment in the pump stations, with potential for electrical shock and fire.
- Working on the side of the tar road with the necessity of persons and equipment having to cross the road in face of oncoming traffic.
- Erection of travelling gun, with potential of electrical shock due to faulty electrical installations etc.
- Dusty conditions resulting from land clearing and preparation activities.
- Possibility of lightning strikes when electrical storms are prevalent during the summer months.
- Possibility of runaway veld fires resulting from burning of de-bushed vegetation.
- Potentially dangerous existing services, i.e. gas lines, water and sewage mains, electrical high voltage cables, buried and overhead
- Deep excavations in soils requiring shoring or reducing of slopes
- Blasting of hard rock or demolition of concrete
- High pressure during testing of the pipe lines, which could result in potentially dangerous situations in the event of the pipeline or fittings failing
- Movement of construction vehicles on site, taking into consideration steep slopes, other traffic and existing services
- Exposure to possible injuries due to mishandling or failure of power and hand tools
- Non-conformance to specifications with regards to fasteners and materials
- Risks related to general safety and security on site

Additional risks may arise from specific methods of construction selected by the Contractor which are not necessary covered in the above.

### E2 DEFINITIONS

For the purpose of this contract the following shall apply:

- (a) **Employer** where used in the contract documents and in this specification, means the Employer as defined in the General Conditions of Contract and it shall have the exact same meaning as **client** as defined in the Construction Regulations 2003. **Employer** and **client** is therefore interchangeable and shall be read in the context of the relevant document.
- (b) **Contractor** wherever used in the contract documents and in this specification, shall have the same meaning as **Contractor** as defined in the General Conditions of Contract.

In this specification the terms “**principal contractor**” and “**contractor**” are replaced with “**Contractor**” and “**subcontractor**” respectively.

For the purpose of this contract the **Contractor** will, in terms of OHS Act 1993, be the mandatory, without derogating from his status as an employer in his own right.

- (c) “**Engineer**” where used in this specification, means the Engineer as defined in the General Conditions of Contract. In terms of the Construction Regulations the Engineer may act as agent on behalf of the Employer (the client as defined in the Construction Regulations).

### **E3 TENDERS**

The Contractor shall submit the following with his tender:

- (a) a documented Health and Safety Plan as stipulated in Regulation 5 of the Construction Regulations. The Safety Plan must be based on the Construction Regulations 2003 and will be subject to approval by the Employer;
- (b) a declaration to the effect that he has the competence and necessary resources to carry out the work safely in compliance with the Construction Regulations 2003;
- (c) a declaration to the effect that he made provision in his tender for the cost of the health and safety measures envisaged in the Construction Regulations.
- (d) Failure to submit the foregoing with his tender, will lead to the conclusion that the Contractor will not be able to carry out the work under the contract safely in accordance with the Construction Regulations.

### **E4 NOTIFICATION OF COMMENCEMENT OF CONSTRUCTION WORK**

After award of the contract, but before commencement of construction work, the Contractor shall, in terms of Regulation 3, notify the Provincial Director of the Department of Labour in writing if the following work is involved:

- (a) the demolition of structures and dismantling of fixed plant of height of 3,0m or more;
- (b) the use of explosives;
- (c) construction work that will exceed 30 days or 300 person-days;
- (e) excavation work deeper than 1,0m; or
- (f) working at a height greater than 3,0m above ground or landings.

The notification must be done in the form of the pro forma included under Section 9 (Forms to be completed by Successful Tenderer) of the tender document.

A copy of the notification form must be kept on site, available for inspection by inspectors, Employer, Engineer, employees and persons on site.

### **E5 RISK ASSESSMENT**

Before commencement of any construction work during the construction period, the Contractor shall have a risk assessment performed and recorded in writing by a competent person. (Refer Regulation 7 of the Construction Regulations 2003).

The risk assessment shall identify and evaluate the risks and hazards that may be expected during the execution of the work under the contract, and it shall include a documented plan of safe work procedures to mitigate, reduce or control the risks and hazards identified.

The risk assessment shall be available on site for inspection by inspectors, Employer, Engineer, subcontractors, employees, trade unions and health and safety committee members, and must be



---

monitored and reviewed periodically by the Contractor.

## **E6 APPOINTMENT OF EMPLOYEES AND SUBCONTRACTORS**

### **E6.1 Health and Safety plan**

The Contractor shall appoint his employees and any subcontractors to be employed on the contract, in writing, and he shall provide them with a copy of his documented Health and Safety Plan, or relevant sections thereof. The Contractor shall ensure that all subcontractors and employees are committed to the implementation of his Safety Plan.

### **E6.2 Health and safety induction training**

The Contractor shall ensure that all employees under his control, including subcontractors and their employees, undergo a health and safety induction training course by a competent person before commencement of construction work. No visitor or other person shall be allowed or permitted to enter the site of the works unless such person has undergone health and safety training pertaining to hazards prevalent on site.

The Contractor shall ensure that every employee on site shall at all times be in possession of proof of the health and safety induction training issued by a competent person prior to commencement of construction work.

## **E7. APPOINTMENT OF SAFETY PERSONNEL**

### **E7.1 Construction Supervisor**

The Contractor shall appoint a full-time **Construction Supervisor** with the duty of supervising the performance of the construction work.

He may also have to appoint one or more competent employees to assist the construction supervisor where justified by the scope and complexity of the works.

### **E7.2 Construction safety officer**

Taking into consideration the size of the project and the hazards or dangers that can be expected, the Contractor shall appoint in writing a full-time or part-time **Construction Safety Officer** if so decided by the Inspector of the Department of Labour. The Safety Officer shall have the necessary competence and resources to perform his duties diligently.

Provision shall be made by the Contractor in his rates, to cover the cost of this dedicated construction safety officer appointed after award of the contract.

### **E7.3 Health and safety representatives**

In terms of **Section 17 and 18 of the Act (OHSA 1993)** the Contractor, being the employer in terms of the Act for the execution of the contract, shall appoint a **health and safety representative** whenever he has more than 20 employees in his employment on the site of the works. The health and safety representative must be selected from employees who are employed in a full-time capacity at a specific workplace.

The number of health and safety representatives for a workplace shall be at least one for every 100 employees.

The function of health and safety representative(s) will be to review the effectiveness of health and safety measures, to identify potential hazards and major incidents, to examine causes of incidents (in collaboration with his employer, the Contractor), to investigate complaints by employees relating to health and safety at work, to make representations to the employer (Contractor) or inspector on general matters affecting the health and safety of employees, to inspect the workplace, plant, machinery etc. on a regular base, to participate in consultations with inspectors and to attend meetings of the health and safety

committee.

#### **E7.4 Health and safety committee**

In terms of Sections **17 and 18 of the Act (OHS Act 1993)** the Contractor (as employer), shall establish one or more **health and safety committee(s)** where there are two or more health and safety representatives at a workplace. The persons selected by the Contractor to serve on the committee shall be designated in writing.

The function of the health and safety committee shall be to hold meetings at regular intervals, but at least once every three months, to review the health and safety measures on the contract, to discuss incidents related to health and safety with the Contractor and the inspector, and to make recommendations regarding health and safety to the Contractor and to keep record of recommendations and reports made by the committee.

#### **E7.5 Competent persons**

In accordance with the Construction Regulations the Contractor has to appoint in writing **competent persons** responsible for supervising construction work on each of the following work situations that may be expected on the site of the works.

- (a) Risk assessment and induction training as described in Regulation 7 of the Construction Regulations;
- (b) Fall protection as described in Regulation 8;
- (c) Formwork and support work as described in Regulation 10;
- (f) Excavation work as described in Regulation 11;
- (g) Demolition work as described in Regulation 12;
- (h) Scaffolding work as described in Regulation 14;
- (i) Suspended platform operations as described in Regulation 15;
- (j) Material hoists as described in Regulation 17;
- (k) Batch plant operations as described in Regulation 18;
- (l) Explosive powered tools as described in Regulation 19;
- (m) Cranes as described in Regulation 20;
- (n) Construction vehicle and mobile plant inspections on a daily basis by a competent person as described in Regulation 21(1);
- (o) Control of all temporary electrical installation on the construction site as described in Regulation 22;
- (p) Stacking and storage on construction sites as described in Regulation 26; and
- (q) Inspections of fire equipment as described in Regulation 27.

A competent person may be appointed for more than one part of the construction work with the understanding that the person must be suitably qualified and able to supervise at the same time the construction work on all the work situations for which he has been appointed.

The appointment of competent persons to supervise parts of the construction work does not relieve the Contractor from any of his responsibilities to comply with **all** requirements of the Construction Regulations.

### **E8. RECORDS AND REGISTERS**

In accordance with the Construction Regulations the Contractor is bound to keep records and registers related to health and safety on site for periodic inspection by inspectors, the Engineer, the Employer, trade union officials and subcontractors and employees. The following records and registers must be kept on site and shall be available for inspection at all times.

- (a) A copy of the OHS Act 1993 Construction Regulations 2003;
- (b) A copy of this Health and Safety Specification;
- (c) A copy of the Contractor's Health and Safety Plan (Regulation 4);
- (d) A copy of the Notification of Construction Work (Regulation 3);
- (e) A health and safety file in terms of Regulation 5(7) with inputs by the Construction Safety Officer (Regulation 6(7));
- (f) A copy of the risk assessment described in Regulation 7;

- (g) A full protection plan and the corresponding records of evaluation and training of employees working from elevated positions as described in Regulation 8;
- (h) Drawings pertaining to the design of structures (Regulation 9(3)) and formwork and support work structures (Regulation 10(d)) must be kept on site;
- (i) Pronouncement of the safety of excavations must be recorded in a register to be kept on site (Regulation 11(3)(h));
- (j) A copy of the certificate of the system design for suspended platforms (Regulation 15(3));
- (k) A notice must be affixed around the base towers of material hoists to indicate the maximum mass load, which may be carried at any one time by material hoists (Regulation 7(5));
- (l) Maintenance records of material hoists and inspection results must be kept in a record book to be kept on site (Regulation 17(8));
- (m) A record of any repairs to or maintenance of a batch plant must be kept on site (Regulations 18(9));
- (n) A warning notice must be displayed in a conspicuous manner when and wherever an explosive powered tool is used (Regulation 19(2));
- (o) A register for recording of findings by the competent person appointed to inspect construction vehicles and mobile plant (Regulation 21(1)(j)).

## **E9. CONTRACTORS RESPONSIBILITIES**

For this contract the Contractor will be the mandatory of the Employer (Client), as defined in the Act (OHSA 1993), which means that the Contractor has the status of employer in his own right in respect of the contract. The Contractor is therefore responsible for all the duties and obligations of an employer as set out in the Act (OHSA 1993) and the Construction Regulations 2003.

Before commencement of work under the contract, the Contractor shall enter into an agreement with the Employer (Client) to confirm his status as mandatory (employer) for the contract under consideration.

The Contractor's duties and responsibilities are clearly set out in the Construction Regulations 2003, and are not repeated in detail but some important aspects are highlighted hereafter, without relieving the Contractor of any of his duties and responsibilities in terms of the Construction Regulations.

### **(a) Contractor's position in relation to the Employer (Client) (Regulation 4)**

In accordance with Section 4 of the Regulations, the Contractor shall liaise closely with the Employer or the Engineer on behalf of the Employer, to ensure that all requirements of the Act and the Regulations are met and complied with.

### **(b) The Principal Contractor and Contractor (Regulation 5)**

The Contractor is in terms of the definition in Regulation 2(b) the equivalent of Principle Contractor as defined in the Construction Regulations, and he shall comply with all the provisions of Regulation 5.

Any subcontractors employed by the Contractor must be appointed in writing, setting out the terms of the appointment in respect of health and safety. An independent subcontractor shall however provide and demonstrate to the Contractor a suitable, acceptable and sufficiently documented health and safety plan before commencement of the subcontract. In the absence of such a health and safety plan the subcontractor shall undertake in writing that he will comply with the Contractor's safety plan, the health and safety specifications of the Employer and the Construction Regulations 2003.

### **(c) Supervision of construction work (Regulation 6)**

The Contractor shall appoint the safety and other personnel and employees as required in terms of Regulation 6 and as set out in paragraph 7 above. Appointment of those personnel and employees does not relieve the Contractor from any of the obligations under Regulation 6.

(d) Risk assessment (Regulation 7)

The Contractor shall have the risk assessment made as set out in paragraph 7 above before commencement of the work and it must be available on site for inspection at all times. The Contractor shall consult with the health and safety committee or health and safety representative(s) etc. on a regular basis to ensure that all employees, including subcontractors under his control, are informed and trained by a competent person regarding health hazards and related work procedures.

No subcontractor, employee or visitor shall be allowed to enter the site of works without prior health and safety induction training, all as specified in Regulation 7.

(e) Fall protection (Regulation 8)

Fall protection, if applicable to this contract shall comply in all respects with Regulation 8 of the Construction Regulations.

(f) Structures (Regulation 9)

The Contractor will be liable for all claims arising from collapse or failure of structures if he failed to comply with all the specifications, project specifications and drawings related to the structures, unless it can be proved that such collapse or failure can be attributed to faulty design or insufficient design standards on which the specifications and the drawings are based.

In addition the Contractor shall comply with all aspects of Regulation 9 of the Construction Regulations.

(g) Formwork and support work (Regulation 10)

The Contractor will be responsible for the adequate design of all formwork and support structures by a competent person.

All drawings pertaining to formwork shall be kept on site and all equipment and materials used in formwork, shall be carefully examined and checked for suitability by a competent person.

The provisions of Regulation 10 of the Construction Regulations shall be followed in every detail.

(h) Excavation work (Regulation 11)

It is essential that the Contractor shall follow the instructions and precautions in the Standard Specifications and Project Specifications as well as the provisions of the Construction Regulations to the letter as unsafe excavations can be a major hazard on any construction site. The Contractor shall therefore ensure that all excavation work is carried out under the supervision of a competent person, that inspections are carried out by a Professional Engineer or Technologist, and that all work is done in such a manner that no hazards are created by unsafe excavations and working conditions.

Supervision by a competent person will not relieve the Contractor from any of his duties and responsibilities under Regulation 11 of the Construction Regulations.

(i) Demolition work (Regulation 12)

Whenever demolition work is included in a contract, the Contractor shall comply with all the requirements of Regulation 12 of the Construction Regulations. The fact that a competent person has to be appointed by the Contractor does not relieve the Contractor from any of his responsibilities in respect of safety of demolition work.

(j) Tunnelling (Regulation 13)

The Contractor shall comply with Regulation 13 wherever tunnelling of any kind is involved.

(k) Scaffolding (Regulation 14)

The Contractor shall ensure that all the provisions of Regulation 14 of the Construction Regulations are complied with. [Note: Reference in the Regulations to "Section 44 of the Act" should read "Section 43 of the Act"].

(l) Suspended platforms (Regulation 15)

Wherever suspended platforms will be necessary on any contract, the Contractor shall ensure that copies of the system design issued by a Professional Engineer are submitted to the Engineer for inspection and approval. The Contractor shall appoint competent persons as supervisors and competent scaffold erectors, operators and inspectors and ensure that all work related to suspended platforms are done in accordance with Regulation 15 of the Construction Regulations.

(m) Boatswain's chains (Regulation 16)

Where boatswain's chains are required on the construction site, the Contractor shall comply with Regulation 16.

(n) Material Hoists (Regulation 17)

Wherever applicable, the Contractor shall comply with the provisions of Regulation 17 to the letter.

(o) Batch plants (Regulation 18)

Wherever applicable, the Contractor shall ensure that all lifting machines, lifting tackle, conveyors, etc. used in the operation of a batch plant shall comply with, and that all operators, supervisors and employees are strictly held to the provisions of Regulation 18. The Contractor shall ensure that the General Safety Regulations (Government Notice R1031 of 30 May 1986), the Driven Machinery Regulations (Government Notice R295 of 26/2/1988) and the Electrical Installation Regulations (Government Notice R2271 of 11/10/1995) are adhered to by all involved.

In terms of the Regulations, records of repairs and maintenance shall be kept on site.

(p) Explosive powered tools (Regulation 19)

The Contractor shall ensure that, wherever explosive-powered tools are required to be used, all safety provisions of Regulation 19 are complied with.

It is especially important that warning notices are displayed and that the issue and return of cartridges and spent cartridges be recorded in a register to be kept on site.

(q) Cranes (Regulation 20)

Wherever the use of tower cranes becomes necessary, the provisions of Regulation 20 shall be complied with.

(r) Construction vehicles And mobile plant (Regulation 21)

The Contractor shall ensure that all construction vehicles and plant are in good working condition and safe for use, and that they are used in accordance with their design and intended use. The vehicles and plant shall only be operated by workers or operators who have received appropriate training, all in accordance with all the requirements of Regulation 21.

All vehicles and plant must be inspected on a daily basis, prior to use, by a competent person and the findings must be recorded in a register to be kept on site.

(s) Electrical installation and machinery on construction sites (Regulation 22)

The Contractor shall comply with the Electrical Installation Regulations (Government Notice R2920 of 23 October 1992) and the Electrical Machinery Regulations (Government Notice R1953 of 12 August 1993). Before commencement of construction, the Contractor shall take adequate steps to ascertain the presence of, and guard against dangers and hazards due to electrical cables and apparatus under, over or on the site.

All temporary electrical installations on the site shall be under the control of a competent person, without relieving the Contractor of his responsibility for the health and safety of all workers and persons on site in terms of Regulation 22.

(t) Use of temporary storage of flammable liquids on construction sites (Regulation 23)

The Contractor shall comply with the provisions of the General Safety Regulations (Government Notice R1031 of 30 May 1986) and all the provisions of Regulation 23 of the Construction Regulations to ensure a safe and hazard-free environment to all workers and other persons on site.

(u) Water environments (Regulation 24)

Where construction work is done over or in close proximity to water, the provisions of Regulation 24 shall apply.

(v) Housekeeping on Construction sites (Regulation 25)

Housekeeping on all construction sites shall be in accordance with the provisions of the environment Regulations for workplaces (Government Notice R2281 of 16 October 1987) and all the provisions of Regulation 25 of the Construction Regulations.

(w) Stacking and storage on construction sites (Regulation 26)

The provisions for the stacking of articles contained in the General Safety Regulations (Government Notice R1031 of 30 May 1986) as well as all the provisions Regulation 26 of the Construction Regulations shall apply.

(x) Fire precautions on construction sites (Regulation 27)

The provisions of the Environmental Regulations for Workplaces (Government Notice R2281 of 16 October 1987) shall apply.

In addition the necessary precautions shall be taken to prevent the incidence of fires, to provide adequate and sufficient fire protection equipment, sirens, escape routes etc. all in accordance with Regulation 27 of the Construction Regulations.

(y) Construction welfare facilities (Regulation 28)

The Contractor shall comply with the construction site provisions as in the Facilities Regulations (Government Notice R1593 of 12 August 1988) and the provisions of Regulation 28 of the Construction Regulations.

(z) Non-compliance with the Construction Regulations 2003

The foregoing is a summary of parts of the Construction Regulations applicable to all construction projects.

The Contractor, as employer for the execution of the contract, shall ensure that all provisions of the Construction Regulations applicable to the contract under consideration are complied with to the letter.

Should the Contractor fail to comply with the provisions of the Regulations 3 to 28 as listed in Regulation 30, he will be guilty of an offence and will be liable, upon conviction, to the fines or

---

imprisonment as set out in Regulation 30.

***The Contractor is advised in his own interest to make a careful study of the Act and the Construction Regulations as ignorance of the Act and the Regulations will not be accepted in any proceedings related to non-conformance to the Act and the Regulations.***

## **E10. MEASUREMENT AND PAYMENT**

### **E10.1 Principles**

It is a condition of this contract that Contractors, who submit tenders for this contract, shall make provision in their tenders for the cost of all health and safety measures during the construction process. All associated activities and expenditure are deemed to be included in the Contractor's tendered rates and prices.

#### **(a) Safety personnel**

The Construction Supervisor, the Construction Safety Officer, Health and Safety Representatives, Health and Safety Committee and Competent Persons referred to in clauses 7.1 to 7.5 shall be members of the Contractor's personnel, and no additional payment will be made for the appointment of such safety personnel.

#### **(b) Records and Registers**

The keeping of health and safety-related records and registers as described in 8 is regarded as a normal duty of the Contractor for which no additional payment will be considered, and which is deemed to be included in the Contractor's tendered rates and prices.

## PART C 4: SITE INFORMATION

### C4.1: LOCALITY PLAN



Locality Maps showing the location of Royal field farm



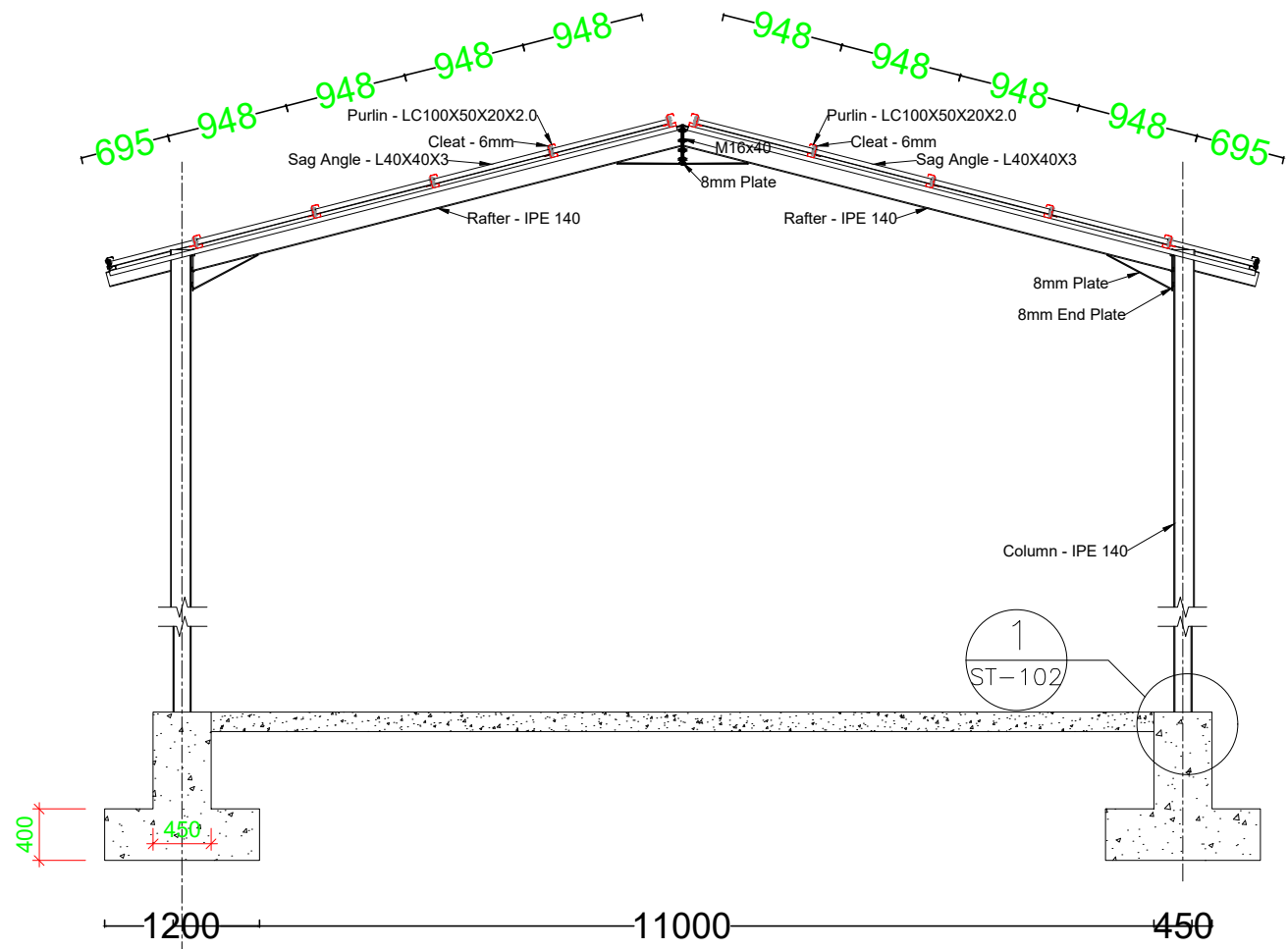

# Crosssectional View

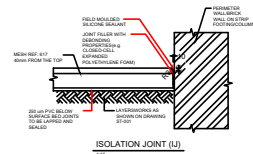
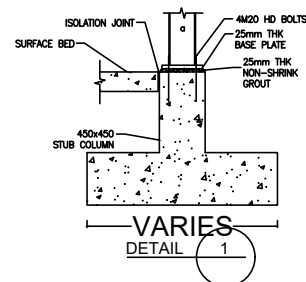
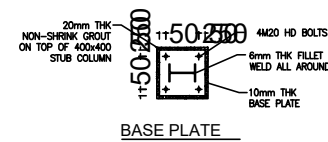
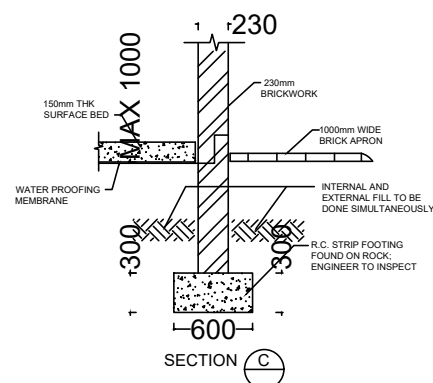
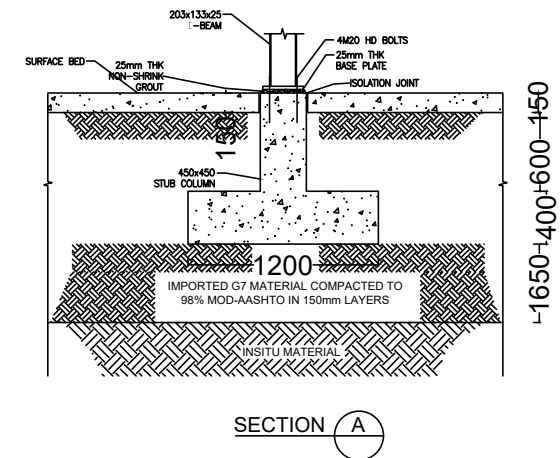
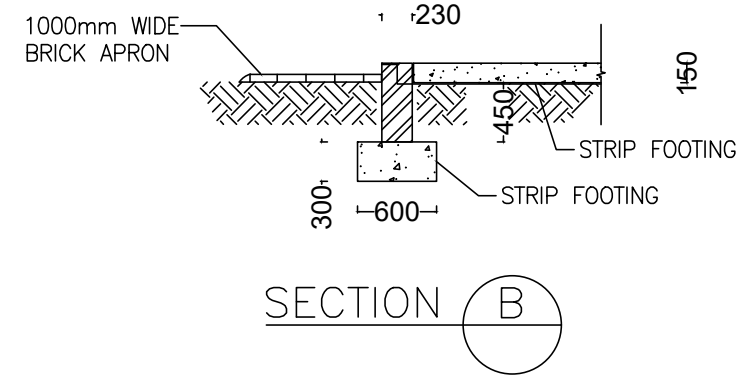

DEPARTMENT OF AGRICULTURE AND RURAL DEVELOPMENT			
DRAWN: M SIGEDA	 <b>DEPARTMENT OF AGRICULTURE AND RURAL DEVELOPMENT</b>	ROYAL FARM FEILDS	SCALE:
DESIGN: M SIGEDA		NETHONONDA A	DATE: 14/03/2023
PROJ. LEADER:			DRAWING NO. RFF02
CHECKED: AP MUTSWANA	APPROVED: L NEMAKHAVHANI		

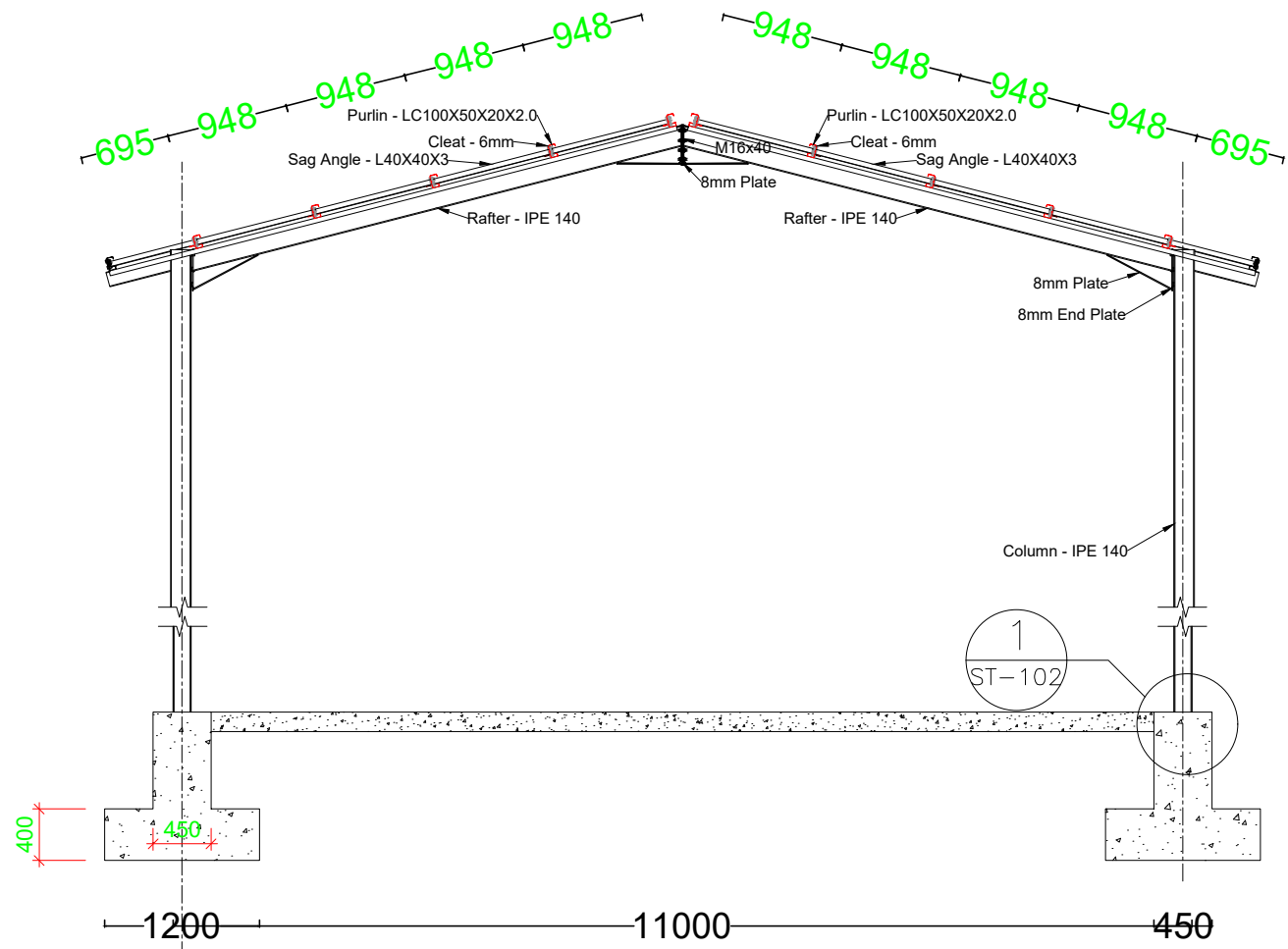

# Crosssectional View

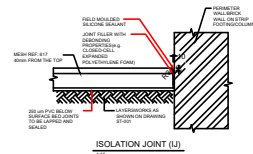
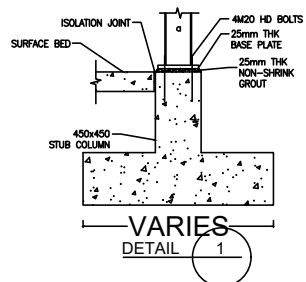
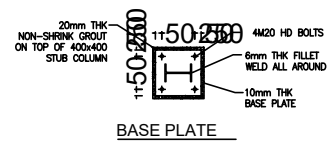
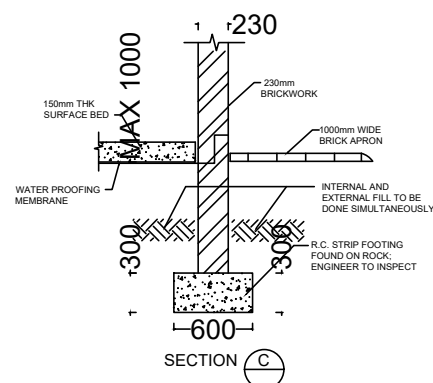
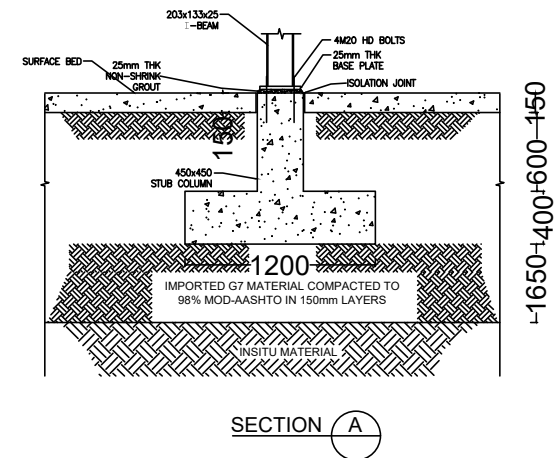
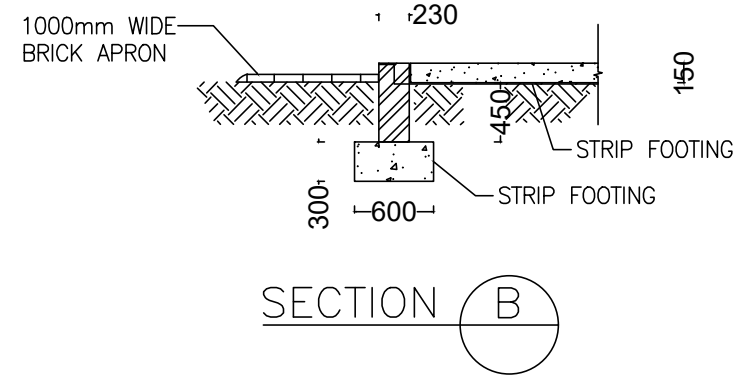

DEPARTMENT OF AGRICULTURE AND RURAL DEVELOPMENT			
DRAWN: M SIGEDA	 <b>DEPARTMENT OF AGRICULTURE AND RURAL DEVELOPMENT</b>	ROYAL FARM FEILDS	SCALE:
DESIGN: M SIGEDA		NETHONONDA A	DATE: 14/03/2023
PROJ. LEADER:			DRAWING NO. RFF02
CHECKED: AP MUTSWANA	APPROVED: L NEMAKHAVHANI		

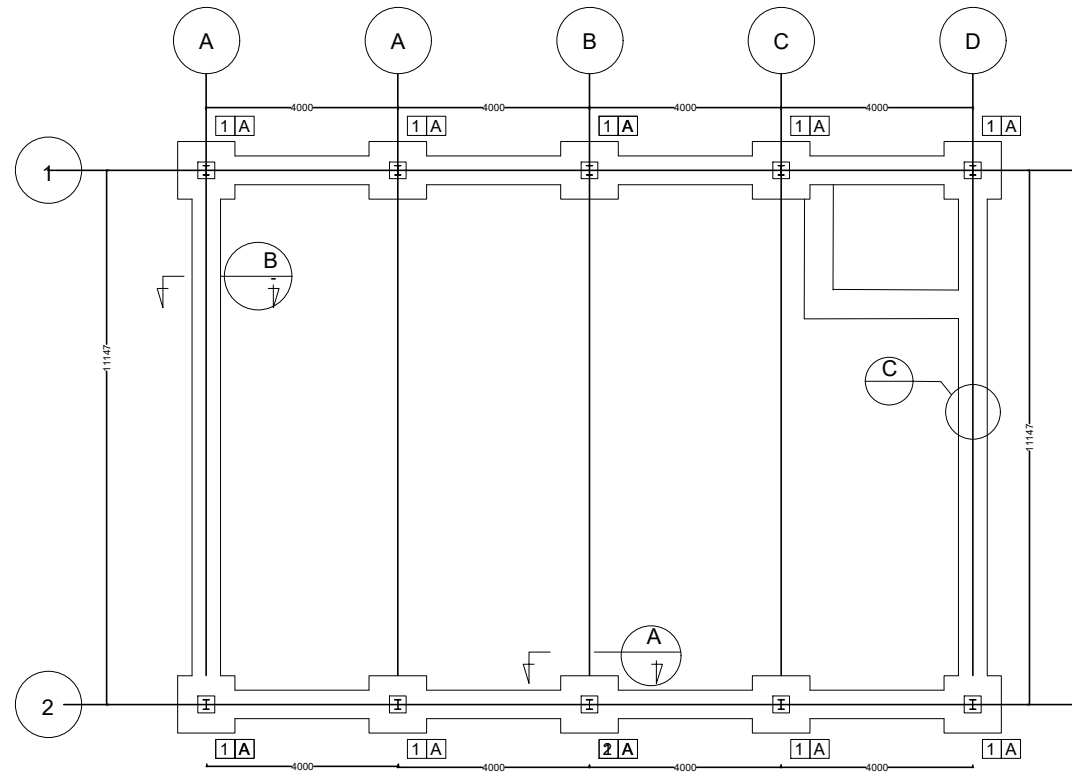

Plan Layout

**FOOTING LEGEND:**  
 1 - 1200x1200x400mm THK R.C. FOOTING  
 A - 203x133x25 I-COLUMN  
 ALL STUB COLUMNS TO BE 450x450 R.C COLUMNS.  
 ALL STRIP FOOTINGS TO BE 600mm WIDE AND 300mm DEEP.

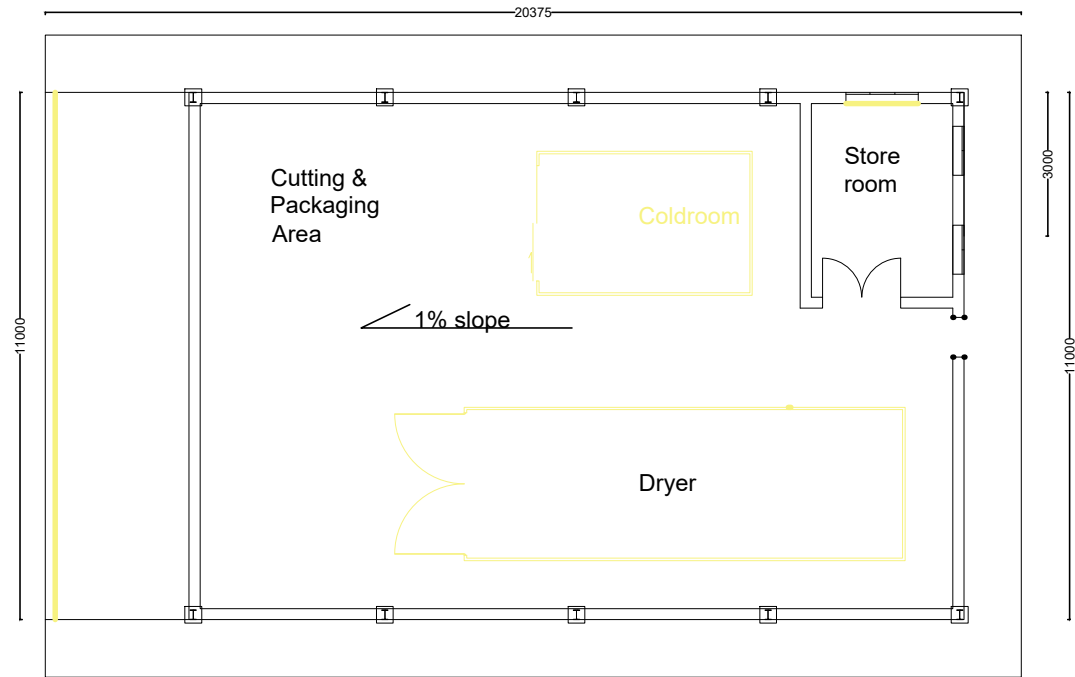

Foundation Layout

DEPARTMENT OF AGRICULTURE AND RURAL DEVELOPMENT			
DRAWN: M SIGEDA	 <b>DEPARTMENT OF AGRICULTURE AND RURAL DEVELOPMENT</b>	ROYAL FARM FEILDS	SCALE:
DESIGN: M SIGEDA		NETHONONDA A	DATE: 14/03/2023
PROJ. LEADER:			DRAWING NO. RFF03
CHECKED: AP MUTSWANA	APPROVED: L NEMAKHAVHANI		

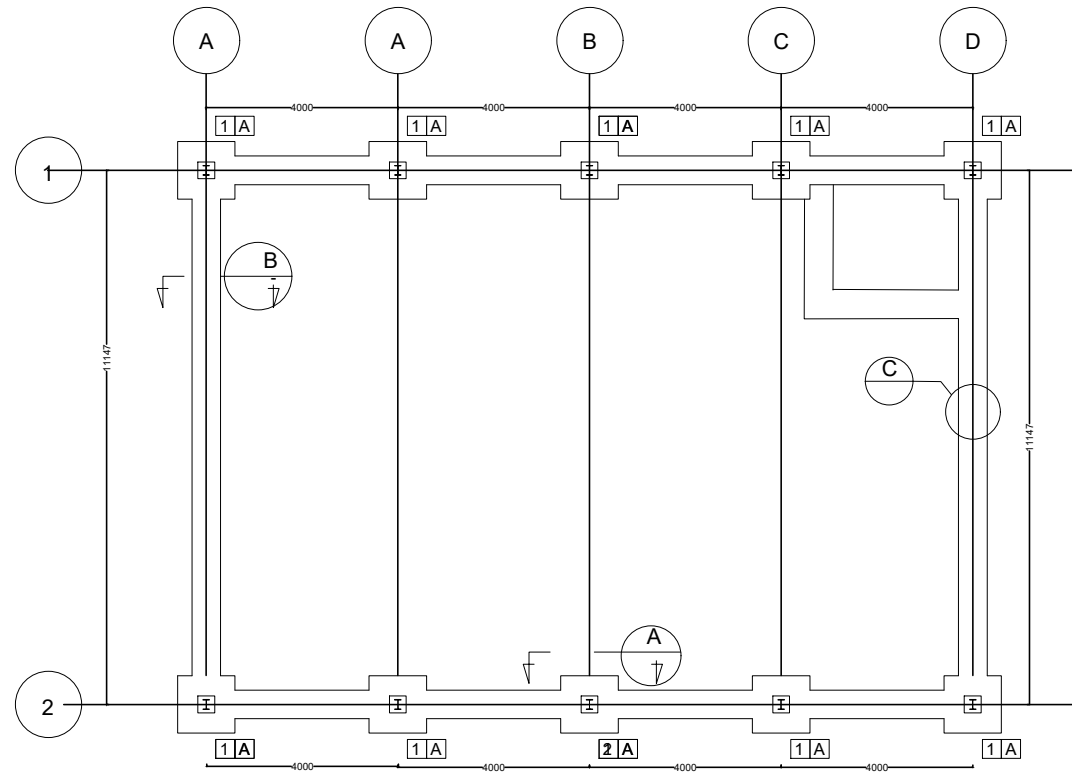

Plan Layout

**FOOTING LEGEND:**  
 1 - 1200x1200x400mm THK R.C. FOOTING  
 A - 203x133x25 I-COLUMN  
 ALL STUB COLUMNS TO BE 450x450 R.C COLUMNS.  
 ALL STRIP FOOTINGS TO BE 600mm WIDE AND 300mm DEEP.

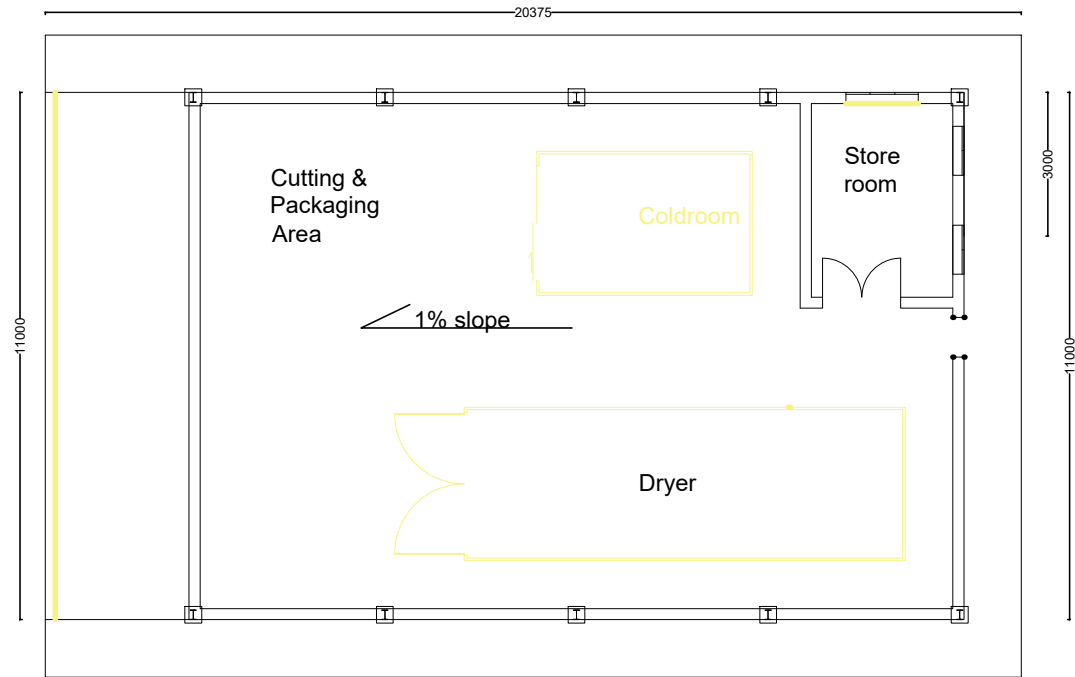

Foundation Layout

DEPARTMENT OF AGRICULTURE AND RURAL DEVELOPMENT			
DRAWN: M SIGEDA	 <b>DEPARTMENT OF AGRICULTURE AND RURAL DEVELOPMENT</b>	ROYAL FARM FEILDS	SCALE:
DESIGN: M SIGEDA		NETHONONDA A	DATE: 14/03/2023
PROJ. LEADER:			DRAWING NO. RFF03
CHECKED: AP MUTSWANA	APPROVED: L NEMAKHAVHANI		

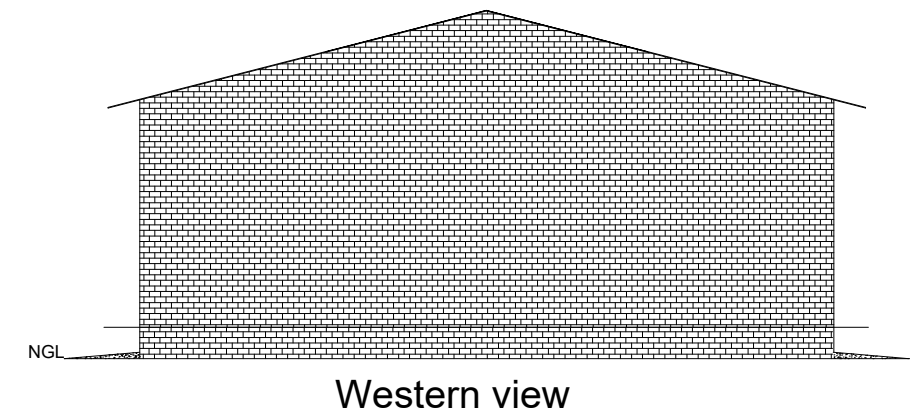
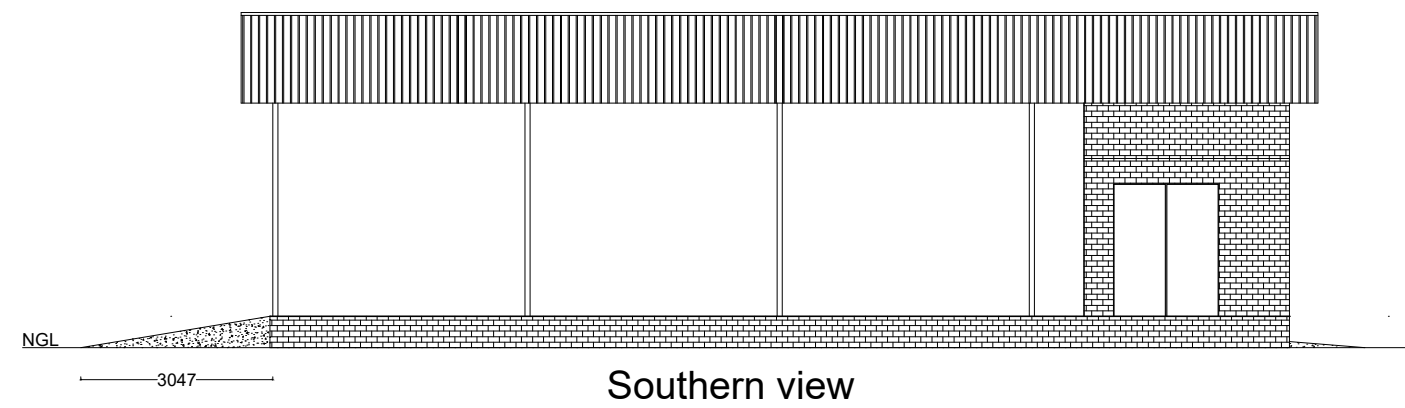
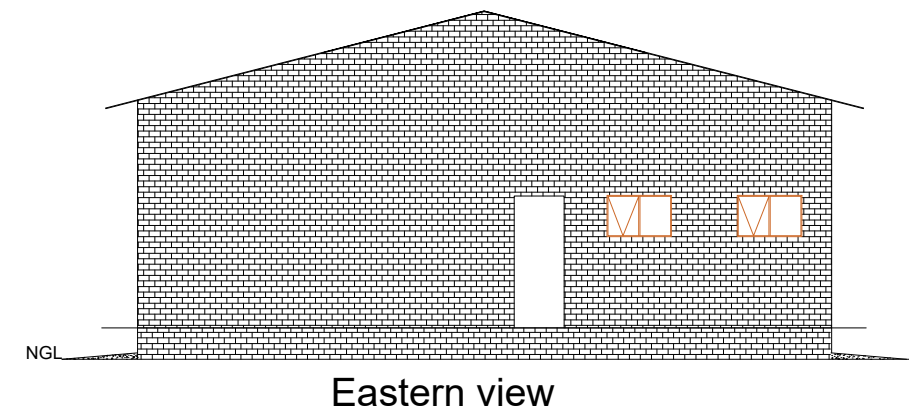
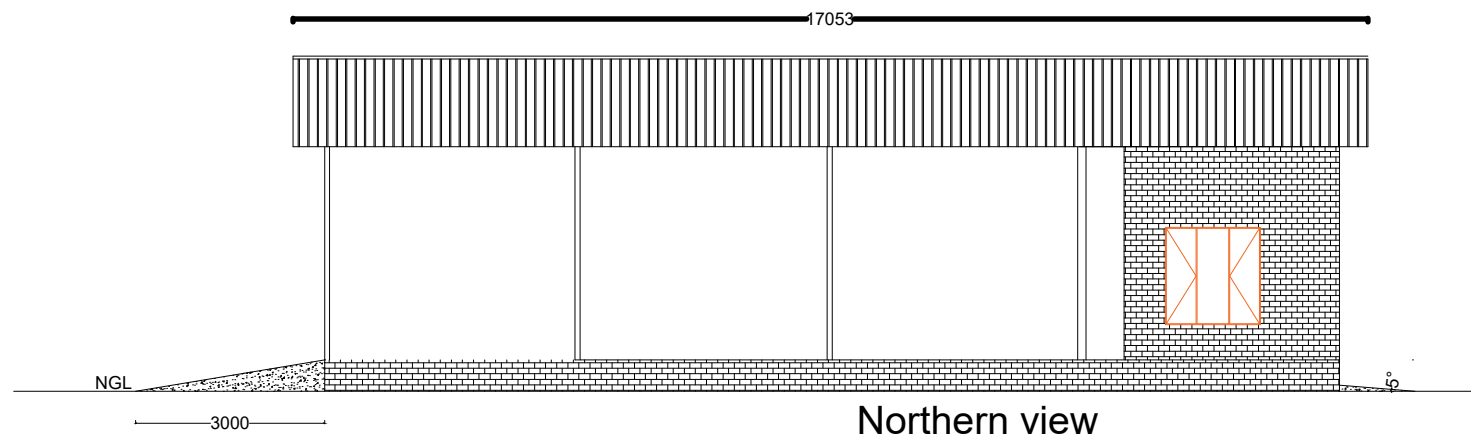

DEPARTMENT OF AGRICULTURE AND RURAL DEVELOPMENT			
DRAWN: M SIGEDA		ROYAL FARM FEILDS	SCALE:
DESIGN: M SIGEDA		NETHONONDA A	DATE: 14/03/2023
PROJ. LEADER:			DRAWING NO. RFF01
CHECKED: AP MUTSWANA	APPROVED: L NEMAKHAVHANI		

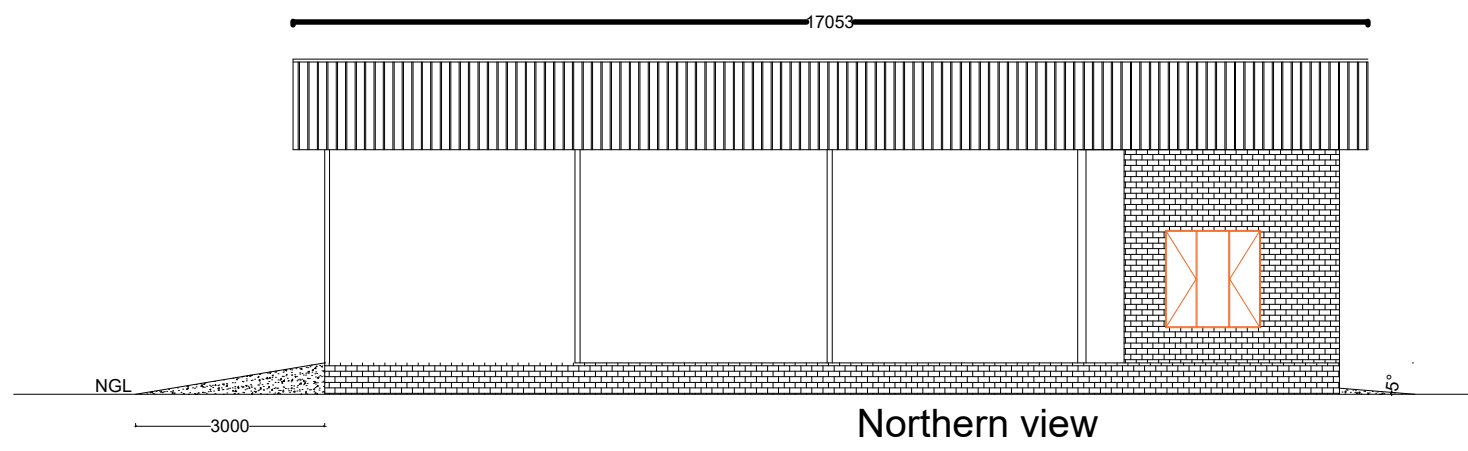

Northern view

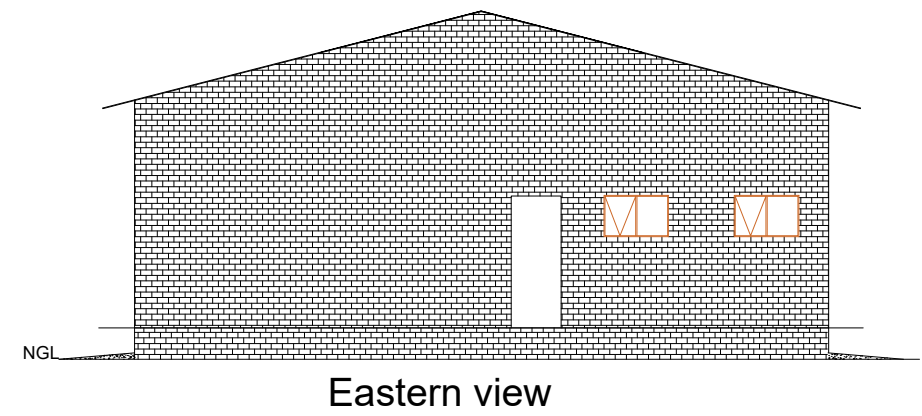

Eastern view

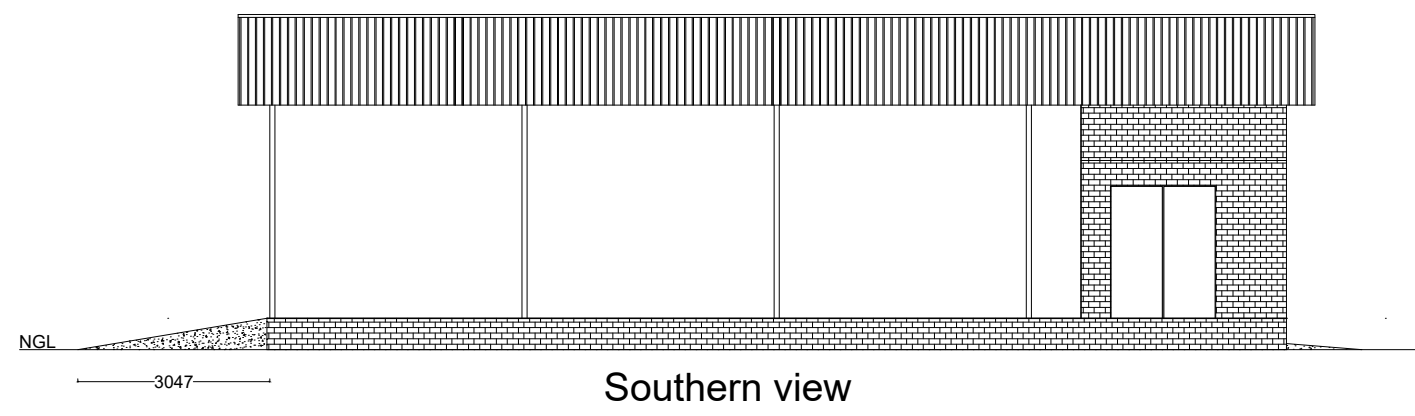

Southern view

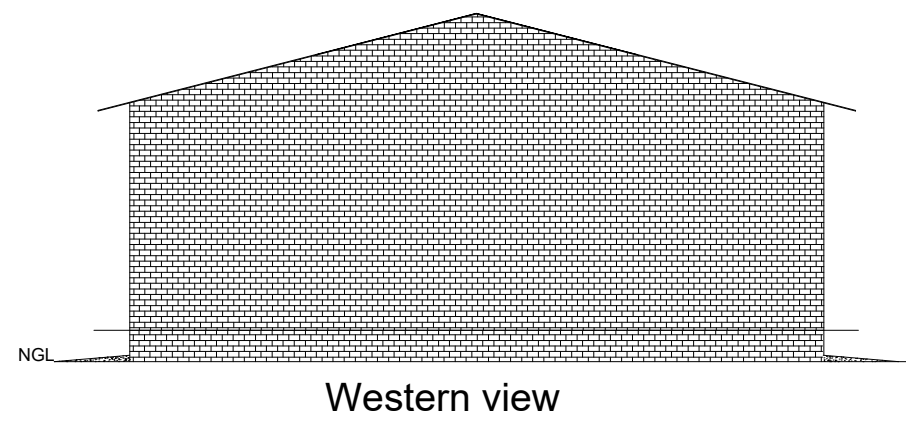

Western view

DEPARTMENT OF AGRICULTURE AND RURAL DEVELOPMENT			
DRAWN: M SIGEDA	 <b>LIMPOPO</b> PROVINCIAL GOVERNMENT REPUBLIC OF SOUTH AFRICA  <b>DEPARTMENT OF</b> <b>AGRICULTURE AND RURAL DEVELOPMENT</b>	ROYAL FARM FEILDS	SCALE:
DESIGN: M SIGEDA		NETHONONDA A	DATE: 14/03/2023
PROJ. LEADER:			DRAWING NO. RFF01
CHECKED: AP MUTSWANA	APPROVED: L NEMAKHAVHANI		